

Handbook

The Eaton UPS and power management  
**Fundamentals handbook**

May 2020

**EATON**  
*Powering Business Worldwide*

Switch  N to Eaton.



# Table of contents

Introduction	4
Questions to consider	5
Top UPS design considerations	6
Other UPS design considerations	8
Automatic transfer switch configurations	9
Six considerations to achieving generator-UPS harmony	10
How to size a UPS	11
Head-to-head UPS comparison for network closets and server rooms	12
UPS cost justification worksheet	13
UPS form factors	14
Input plugs and output receptacles	15
The difference between VA and watts	17
9 ways beer and UPSs are alike	18
UPS startup	19
UPS vs. surge suppressor	20
Decentralized or central UPS?	21
Make giving your UPS a health check-up a top priority	23
What is three-phase power?	24
Increase server energy efficiencies by using high-voltage power supplies and 208V UPSs	25
Worldwide voltage map	26
Worldwide voltages	27
The nine power problems	28
UPS topologies	29
UPS battery overview	30
Factors affecting battery life	32
Transform your power infrastructure with lithium-ion batteries	33
UPS software overview	34
Typical PDU configurations with UPS models	35
Service overview	37
Electric transmission distribution system	38
Frequently asked questions	40
Commonly used acronyms	42
Glossary of power terms	44



# Introduction

## Welcome to the Eaton UPS and Power Management Fundamentals Handbook.

From plug and receptacle charts and facts about power problems to an overview of various UPS topologies and factors affecting battery life, you'll find a wealth of pertinent resources designed to help you develop the optimum solution.

This handbook is your one-stop source for essential information ... whether you need power protection for small, medium or large data centers; health care facilities; or other environments in which ensuring uptime and safeguarding data are critical.

Thanks to Eaton, IT pros are spending fewer nights and weekends at work, leaving their desk toys at the office all alone.

## Why a UPS?

In general, a UPS protects IT equipment and other electrical loads from problems that plague our electrical supply, performing the following three basic functions:

1. Preventing hardware damage typically caused by surges and spikes. Many UPS models continually condition incoming power as well.
2. Preventing data loss and corruption. Without a UPS, devices that are subjected to a hard system shutdown can lose data completely or have it corrupted. In conjunction with power management software, a UPS can facilitate a graceful system shutdown.
3. Providing availability for networks and other applications while preventing downtime. In some cases, they provide enough battery runtime to ride through brief outages; in other cases, they provide hours of runtime to ride through extended power outages. UPSs are also paired with generators to provide enough time for them to power up.



# Questions to consider

WIND ME UP AND I'LL PROGRAM YOUR DATA CENTER TO RUN PERFECTLY.



When it comes to backup power, here are some basic questions to ask yourself.

## Application

1. How often do you refresh and maintain your IT hardware (including servers)? What about your UPS equipment?
2. If you have a converged data-voice network, have you protected all critical switches?
3. If you have virtualized your servers, have you considered the impact on your UPS equipment?
4. What would happen if the power went out at your facility right now?
5. Have you thought about the impact of damaged or corrupted data?
6. How much energy do your UPS units consume? How efficient are they?

## UPS specifics

1. What size UPS do you need? (kVA or amperage)
2. What voltage is currently available at your site?
3. What voltage do you need?
4. What runtime do you want?
5. Are there any clearances or size constraints?
6. Do you have bypass requirements?
7. What types of input and output connections are required?
8. Is there a generator on site?
9. Does the UPS need to be scalable?
10. Do you need redundancy?

## Accessories

1. How is power getting from the UPS to your equipment?
2. Do you have a need for enclosures, communications, seismic mounting, floor stands or rail kits?
3. Is a maintenance bypass switch needed?
4. Are unorganized cables hindering your efficiency or coming a safety concern?

## Software and connectivity

1. Is there a need to have orderly scheduled shutdowns?
2. Do you want to remotely monitor the UPS?
3. Would you like to remotely notify others of UPS events?
4. How will your UPS software manage virtual servers during an extended power outage?
5. Does your power management software integrate easily with your virtualization platforms?
6. Do you need a network card? A network card that has the UL 2900-2-2 cybersecurity certification?

## Service

1. Do you need immediate factory response?
2. What kind of parts and labor coverage do you need?
3. Do you want any type of preventive maintenance?
4. When's the last time you checked the batteries in your existing UPS units?

# Top UPS design considerations

The following factors outline the key design considerations to take into account when analyzing your needs.

## 1. Power environment: single- and three-phase

Understanding your existing power infrastructure is a crucial step in the qualification and sales process. While you may focus on larger, three-phase power systems, the majority of IT managers are dealing primarily with single-phase equipment, often at the rack level.

Many existing computer rooms and small to mid-sized data centers have single-phase loads at the rack level. Ground-up designs are increasingly moving three-phase power to the point of utilization to gain efficiencies and reduce costs, creating great opportunity for three-phase solutions in new construction.

## 2. Installation environment

It's imperative to understand how a prospective UPS will be deployed. Since most environments support several different solutions, you may need to evaluate these options.

## 3. Power load

The VA or watt rating of your power loads is one of the most important factors in identifying the right UPS. After identifying the power environment (if the UPS needs to be single- or three-phase), the size of the UPS further narrows the selection. In single-phase deployments especially, it often makes sense to select a UPS that exceeds current power requirements but offers greater runtimes and allows for future growth.

## 4. Availability and battery runtime

This is where you need to determine your true runtime requirements. While runtime may seem like a simple thing to quantify, understanding the facts behind the numbers help contribute to the development of end-to-end solutions.

Generally, the amount of runtime required can significantly affect the solution cost, but many Eaton solutions are actually more cost-effective in extended runtime applications.

There are four basic battery runtime configurations:

1. UPS with 10 to 15 minutes of runtime and no generator. You are covered for 90 to 95 percent of power outages. You can either use UPS shutdown clients to save your data or stay online as long as possible before the system crashes.
2. UPS with 10 to 15 minutes of runtime and a generator. You have a very reliable setup and most generators will startup within one minute (five minutes maximum). You are covered for most situations.
3. Redundant UPSs, generator and two power feeds for dual-corded servers. You have a lot of money and/or are really worried about the power failing. It's time to get a consultative person on-site to help you figure it out.
4. UPS with two or more hours of battery runtime. In some cases, generators may not be practical and you must rely entirely upon batteries.

MY IT PRO SAYS EATON HELPS HIM TRIM THE FAT. FRANKLY, I'M A LITTLE WORRIED.





### 5. Form factor

How much space are you willing to designate to your UPS? Where do you plan to install it? Answering these questions will help you determine whether your environment is better suited for a tower or rackmount model. Some UPSs have a 2-in-1 form factor, allowing you to deploy the unit either way.

### 6. Scalability

It's always important to consider your future expansion needs when evaluating solutions. Eaton's scalable UPS solutions provide a competitive advantage by offering a cost-effective way to increase capacity. Virtually all Eaton UPSs with a 6 kVA or greater power rating offer some form of scalability, either through a simple firmware upgrade, the addition of modular hardware components or the paralleling of multiple UPSs.

For cost-conscious or budget-constrained customers, a UPS with inherent scalability often proves to be the best value in the long run, allowing you to increase capacity without purchasing additional hardware. A simple kVA upgrade is all that's needed to enable a UPS with inherent scalability to operate at full capacity.

You may want to service the UPS yourself. If that's the case, look for a unit that allows you to add capacity with power and/or battery modules.

While modular solutions—including multiple, paralleled systems—are often a more affordable option initially, they can be a more expensive solution over the long term due to added hardware and installation costs. Depending on your needs, a larger, centralized, non-modular system with inherent scalability might ultimately be the most cost-effective solution.

### 7. Power distribution

It is important for you to consider how power will be delivered to your critical equipment. In some cases, you may simply plug loads directly into the UPS. In others, you may need large PDUs to distribute power. You may also incorporate rack-based power distribution units into your design.

### 8. Manageability

While a UPS protects the attached load during a power outage, power management software is required to ensure that all work-in-progress is saved and that sensitive electronic equipment is gracefully shut down if the power outage exceeds the battery runtime of the UPS. Without software, the UPS simply runs until its batteries are depleted and then drops the load. In addition to this basic functionality of UPS software, you should consider the following monitoring and manageability capabilities:

- Power event notifications, including emails, pop-up alerts and text messages to pre-designated recipients
- Logging of power events
- Advanced capabilities in virtual environments, including integration into VMware's ESXi and vSphere, Microsoft's Hyper-V and Nutanix Ready Acropolis Hypervisor (AHV)
- Dedicated battery monitoring and advanced service notifications
- Remote monitoring by service personnel from the UPS manufacturer

### 9. Operation and maintenance

While you may value the ability to service your own equipment, the vast majority of IT and facility management professionals prefer the peace of mind that comes with full factory support through on-site service or an advanced UPS exchange agreement. To make an informed decision on service support, you must accurately assess your own technical and service capabilities.

Consider UPS and battery safety as there is inherent danger when maintaining them. The more complicated the equipment, the more important it is to have experts perform the maintenance.

### 10. Budget

Although the latest performance features of a UPS may fit nicely with what you are looking for, budget constraints may force you to make trade-off decisions. Be prepared to prioritize your needs for redundancy, scalability, efficiency, software management, modularity and serviceability.

I LOVE MAKING PLANS. EVIL ONES!





# Other UPS design considerations

The following design guidelines should be reviewed and followed prior to ordering the appropriate UPS solution.

## **1. Check to see if there's an adequate electrical supply near the UPS.**

Compare UPS fuse ratings (amps) and breaker types and whether any electrical work may be needed (i.e., cabling to the UPS terminal block input).

## **2. Find out the dimensions of the UPS and include any battery cabinets.**

Make sure your installation site has enough space available.

## **3. Ensure the UPS can be placed in its final position.**

Will the UPS components fit through doors? Are there any stairs? Do you have existing racks that the UPS must fit into? Please consult Eaton's website for detailed UPS dimensions and specifications: [Eaton.com/UPS](https://www.eaton.com/UPS).

## **4. Verify that the floor is strong enough to support the UPS and battery cabinets.**

The UPS and its battery cabinets can be heavy, so make sure the site has the proper floor loading capacity.

## **5. Confirm that the UPS will have adequate ventilation.**

Eaton UPS models use internal fans to cool them. You shouldn't install the UPS in a sealed container or small, sealed room.

## **6. Always be sure which wall receptacle is required to plug in the UPS.**

Only UPSs with power ratings up to 1500 VA plug into a standard 15-amp wall outlet. All others require a larger receptacle, which must be installed by an electrician. Things go more smoothly if you aren't waiting for this to be done after all of the equipment has arrived. Most small and rackmounted computers run on normal 120 volt, 15-amp electrical service. Some computers have power cords that require a higher voltage of 208V or 240V, in which case you'll need a 3000 VA or larger UPS.

## **7. Hardwired connections.**

Hardwired outputs are generally useful if you want the UPS output to be distributed via electrical panels. Using an electrical distribution panel allows for flexibility with receptacles types. If there's no other UPS that fits your receptacle and power requirements, you may need to hardwire it. Hardwired UPS models typically require the use of a certified electrician to wire them to the electrical distribution panel, which could be a more costly option.

## **8. Installing small UPS models behind larger UPS models.**

If you're installing a smaller UPS behind a larger UPS, you must consider the total potential power of the smaller UPS as well as other loads that will be powered by the larger UPS. For example, if you're plugging a 1500 VA UPS into a 10,000 VA UPS, you must consider the load of the smaller UPS rather than just the load that's plugged into it. In addition, the larger UPS must be at least five times larger than the smaller UPS. This design guideline must be followed due to charging capacity that may be required by the smaller UPS; any anomalies associated with the building power, and to avoid overheating or potential over loading of the larger UPS which may result in failure of the all UPS models in the string.

## **9. Using a UPS and a generator together.**

A UPS provides backup power and actively conditions and regulates voltage. Similarly, an auxiliary generator provides backup power, but typically takes 10-15 seconds to start up, depending on its type. For long-term backup servers and IT equipment, this isn't an optimal situation, so during that downtime the UPS kicks in. Basically, the UPS bridges the power gap between loss of power and generator coming online.

When choosing your UPS solution, it's important to keep power ratings in mind; you cannot size a generator in a 1:1 match to the UPS and expect successful results. There are two reasons for this: first, UPSs aren't 100 percent efficient and second, generators need to account for step loads. In addition, very small generators don't often provide enough kinetic energy to provide a smooth transition. As a rule of thumb, for 20 kVA and above, auxiliary generators should be sized 1.5 times the size of the output rating of the UPS in kW, while for 20 kVA and below, they should be two times larger. It's also important to note that gas-powered generators should be sized a bit larger.

## **10. Building codes.**

Verify that the final UPS solution meets local building codes.



# Automatic transfer switch configurations

Automatic transfer switches, like Eaton's eATS Monitored models can be used in a variety of different configurations to monitor and manage connected equipment. Eaton's eATS Monitored models enable seamless switching of non-phase synchronized AC power sources in the event of a power failure. Generally used to provide power redundancy to equipment with a single power supply, the eATS automatically transfers power between sources with no interruption if the primary source fails or requires maintenance, eliminating equipment downtime.

## Dual-feed UPS:

eATS Monitored manages input from a pair of UPSs to create a redundant environment ensuring system uptime.

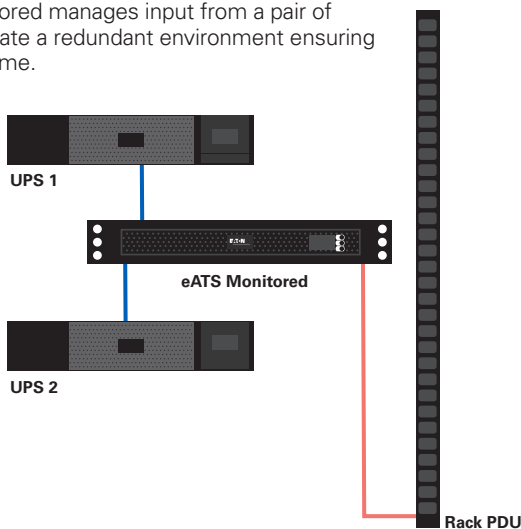

## UPS bypass:

eATS Monitored can be used as a bypass to perform UPS maintenance without losing power to critical applications.

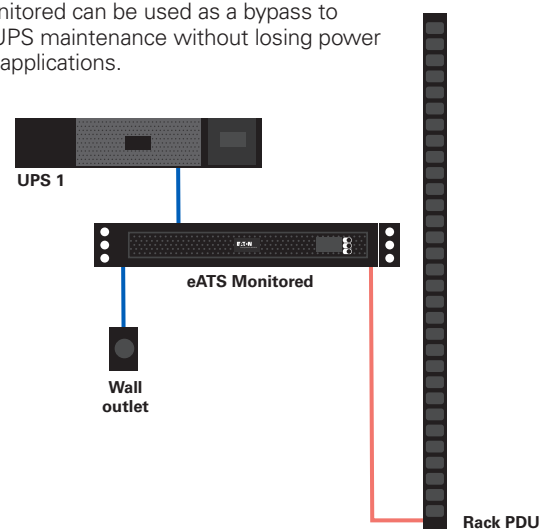

## Dual-feed PDU:

Dual redundancy created for a single output device using A and B feed rack PDUs.

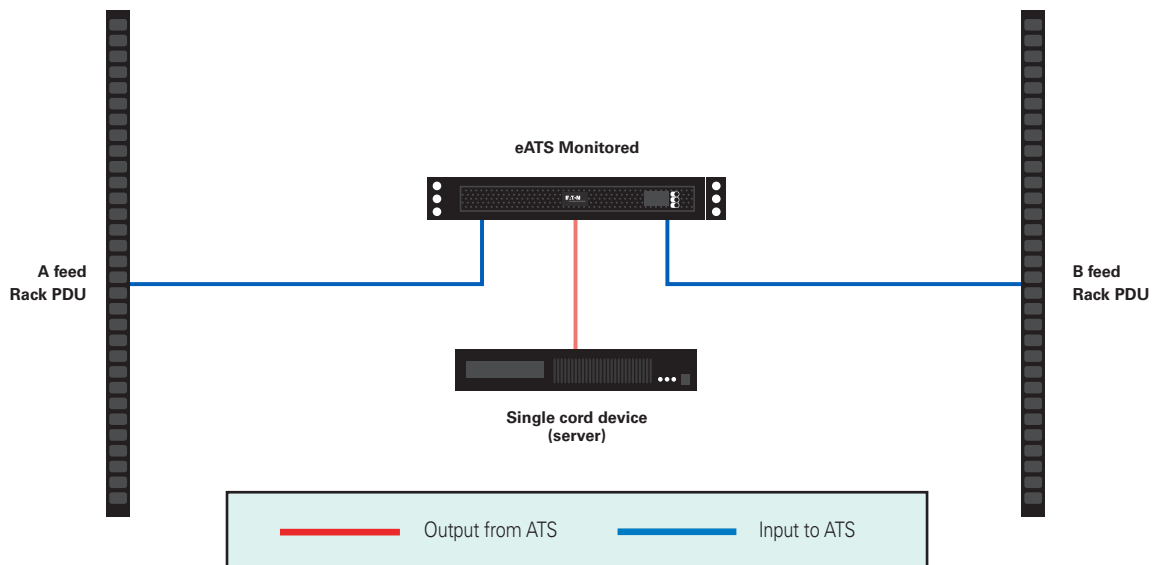

For more information about the eATS Monitored, please visit: [Eaton.com/eATS](https://Eaton.com/eATS)

# Six considerations to achieving generator-UPS harmony

**As an ever-escalating list of threats leave today's mission-critical environments even more vulnerable to downtime, a growing number of organizations are bolstering their level of security by combining an UPS with a backup generator.**

Although UPSs offer an excellent line of defense against dirty power, data loss and equipment damage—as well as provide backup during short-term blackouts—they are not designed to deliver power indefinitely. Enter the standby generator, an ideal complement for applications that must remain online 24/7 without interruption.

Yet, harmonization issues are inherent when interfacing these two devices. Pairing the optimal UPS and generator backup is kind of like a blind date; compatibility is never guaranteed. To help ensure you find the perfect match—and not an epic clashing of personalities—it is vital to understand the operational characteristics, load interaction and design of these devices. Safeguard UPS generator system reliability and performance by taking into account the following considerations:

## 1. Assess the generator frequency.

Every UPS has a set input voltage and frequency window that if exceeded, will cause the UPS to go on battery. If a generator's frequency range is too wide for the UPS to accept, then the UPS may interpret the generator as an unstable power source. If this occurs, the UPS remains on battery permanently, which will ultimately cause the battery to fail and drop your load.

## 2. Size up the generator.

Proper generator sizing is essential to ensuring the safety of both the UPS load and an organization's personnel during a lengthy outage. Many companies expect the generator to accommodate air conditioning, emergency lighting, communications and other vital services. Yet if the generator isn't sized large enough, it won't be able to hold voltage and frequency within input tolerances when the UPS comes online.

The bigger the generator engine, the more stable the frequency, and therefore the more it can handle as the UPS comes off of battery. With that in mind, whenever budgets permit, it is wise to size up and also allow for some potential growth with the generator friendly UPS. The general recommendations for UPS models up to 25 kW are as follows:

- **2 times the total load**  
(including the UPS, A/C, and all other equipment that must remain online) for natural gas-powered and mechanical governor generators
- **1.5 times the total load**  
for propane- or diesel-powered generators and those with an electronic governor

## 3. Consider the fuel source.

The most common generator fuel options include propane, natural gas and diesel, each of which comes with its own set of own advantages and disadvantages. Natural gas-operating generators can be slower to respond and may need to be sized larger than their propane counterparts. Diesel is widely considered the best fuel and is predominant for generator solutions 50 kW and larger; however, it has a short storage life and its cost can strain budgets.

## 4. Don't overlook the governor.

Portable generators are equipped with a governor, which limits the speed of fuel being delivered to the engine to a safe level amid load changes. Electronic governors are quick to respond, while mechanical governors are slower and can also cause calibration challenges.

## 5. Consider the UPS topology.

The type of UPS will also impact UPS generator compatibility and configuration, as not all can compensate for frequency variations without relying on the battery. Both standby and line-interactive UPSs use battery power to prevent frequency variations from affecting the protected load. A double-conversion, online UPS, on the other hand, recreates the sine wave and filters frequency variations as part of its normal operation, thereby preserving battery life. Because it constantly rectifies AC to DC and then inverts the DC back to AC, the online UPS produces an output that corrects for voltage and frequency deviations. For this reason, double-conversion technology is the most common for critical load applications, and the most advantageous type of system for generator integration.

## 6. Consult with the manufacturers.

Often you can avoid a range of potential problems and the UPS not working on generator power by first ensuring that the generator manufacturer has tested and approved the product's intended use with UPSs. To ensure that optimal UPS vs generator sizing is achieved, it is wise to consult with both the UPS and the generator manufacturer prior to finalizing a purchase. In addition, capacities of prospective loads to be protected can generally be found in the manufacturer's specifications.





# Head-to-head UPS comparison for network closets and server rooms



You've narrowed down your UPS choices to two or three models. Now what? How can you make sure that you're making an apples-to-apples comparison? Are you considering all aspects related to total cost of ownership (TCO)? We've created this quick checklist so you can ask yourself the right questions for network closet and server room applications.

**Professor Wattson has lessons on demystifying sizing, ratings, maintenance bypass and network-class UPSs on**

[Switchon.eaton.com/power101](http://Switchon.eaton.com/power101)

Factor	UPS 1	UPS 2
<b>Voltage</b> Be sure the input and output voltages are the same. For example, a 208V UPS will cost more than a standard 120V UPS.		
<b>Power rating</b> UPSs are typically rated in volt-amperes (VA) and watts. Watts measures real power and is the key rating. For example a UPS rated at 1000 VA / 900 watts provides one third more power than one rated at 1000 VA / 600 watts.		
<b>Input plug</b> Do both UPSs have the same input plug? Does it match your wall socket? UPSs 1500 VA and below plug right into a standard wall socket. Larger models may require you to hire an electrician to install a new wall socket.		
<b>Output receptacles</b> Does each UPS have the same quantity of output receptacles? The same type? Be sure the UPS has enough output receptacles and that they'll accommodate the power cords of your servers, etc.		
<b>Warranty</b> Are the warranties the same duration? How long does the warranty cover the batteries?		
<b>User interface</b> Do both UPSs utilize the same interface? Do both have an intuitive LCD or basic LEDs?		
<b>Network card</b> If you need/want a network card, does the UPS price include one? Some UPSs include a card while others do not and this can impact the price. Does the network have both UL 2900-1 and IEC 62443-4-2 cybersecurity certifications?		
<b>Software</b> Do both UPSs have equivalent software capabilities? For example, if integration into VMware vCenter is a priority, be sure the UPS software can do it.		
<b>Mounting hardware</b> Do you plan to mount the UPS in a rack enclosure or 2-post rack? If the mounting is not included with the UPS, you'll likely need to purchase hardware separately.		
<b>Rack height</b> If you are evaluating rack mount UPSs, are they the same rack height (U)? For example, going with a 1U UPS over a 2U model may allow you to fit another server in your rack.		
<b>Maintenance bypass</b> Have you considered the price of a maintenance bypass module that will allow you to keep your IT equipment up and running if you ever need to replace the UPS or if the UPS fails?		
<b>Batteries</b> Have you considered the cost of additional battery packs? The cost of replacing the batteries in the UPS?		

# UPS cost justification worksheet

This worksheet helps you determine the estimated dollar savings that a UPS can deliver. Simply fill in the information to calculate the costs of one hour of downtime. Actual dollar amounts will vary from company to company, location to location, and industry to industry.

1. Number of critical loads:  
*Critical loads = any equipment running or supporting your applications (servers, routers, PCs, network devices, etc.)* ..... \_\_\_\_\_
2. Number of employees using critical loads: ..... \_\_\_\_\_
3. Employees' average hourly earnings: ..... \_\_\_\_\_
4. Estimated cost of lost business per hour of downtime  
*(\$1,000, \$5,000, \$10,000 . . . )* ..... \_\_\_\_\_
5. Cost of service calls per hour: ..... \_\_\_\_\_
6. Cost of recreating or salvaging data (if applicable): ..... \_\_\_\_\_
7. Cost of replacing hardware (if applicable): ..... \_\_\_\_\_
8. Cost of reinstalling software (if applicable): ..... \_\_\_\_\_
9. Lost employee time (line 2 x 3): ..... \_\_\_\_\_
10. Lost business (line 4): ..... \_\_\_\_\_
11. Service (line 5): ..... \_\_\_\_\_
12. Recreating or salvaging data (line 6): ..... \_\_\_\_\_
13. Replaced hardware and software (line 7 + 8): ..... \_\_\_\_\_
14. Estimated total cost per hour of downtime: ..... \$ \_\_\_\_\_

**This is only one hour. Imagine if your systems were down all day!**



# UPS form factors

With applications spanning from desktops to large data centers, UPSs come in a variety of form factors.



## 1. Desktop and tower UPS

- a. The Eaton 3S UPS also fits easily on top of or under a desk.
- b. The Eaton 5P tower UPS fits under a desk or in a network closet.

## 2. Wall-mount UPS

The Eaton 5P rackmount UPS includes hardware to mount it to a wall.

## 3. Rackmount compact UPS

The Eaton 5P rackmount compact UPS features shorter depth than the 5P 1U UPS, providing 4-5 inches of additional clearance.

## 4. Rackmount UPS

The Eaton 9PX UPS ranges from 700 VA to 11 kVA.

## 5. Two-in-one rackmount/tower UPS

The Eaton 5PX UPS can be mounted in a rack or installed as a tower model.

## 6. Scalable UPS

- a. The Eaton BladeUPS is a scalable, redundant rackmount UPS.
- b. The Eaton 93PM is also a scalable, redundant UPS.
- c. The Eaton 93PM is a vertical or horizontal scalable white or grey space solution.

## 7. Large tower UPS

The Power Xpert 9395 UPS is designed to be a central backup for multiple loads, including data centers.

A SOLUTION FOR ANY SITUATION. I COULDN'T HAVE DESIGNED IT BETTER.





# Input plugs and output receptacles

When you receive a UPS, you should be able to plug it in right away. If a UPS can't be plugged into the wall socket, or your equipment can't be plugged into it, you've got a problem.

Any UPS with a rating of 1500 VA or below can be plugged into a standard household receptacle/socket. UPS models with ratings higher than 1500 VA use input plugs that can't be plugged directly into a standard receptacle. Many higher rated UPSs (above 1500 VA) may also be hardwired directly into the electrical distribution panel at the installation location by a licensed electrician.

Many UPS models offer a fixed set of input and output receptacles. Other UPS models can be configured with a custom set of input and output connections.

For reference we've included the following chart to help you visually confirm input and output plug/receptacle options:



\*5-15P can plug into 5-20R

R = Receptacle, P = Plug, L = Locking

For the number before the hyphen:

5 = 125V, two-pole, three-wire (grounded)

6 = 250V, two-pole, three-wire (grounded)

14 = 125/250V, three-pole, four-wire (grounded)

The number after the hyphen indicates the amperage. For example, the L5-30R is a 30A receptacle.

Input plug and output receptacle chart



## Know your North American receptacles

In North American markets, most facilities utilize plugs and receptacles conforming to standards established by the National Electrical Manufacturer's Association (NEMA), which uses a smart code to define what each part number represents. If you know the part number of your connector, you can find its voltage and amperage ratings. Always check with your local electrician to verify proper wiring and installation.







## L 6 - 30 R

L - Locking	Amperage - matches breaker rating feeding the plug/receptacle	R - Receptacle P - Plug
-------------	---	----------------------------

Value	Max Voltage	Wires in connector
5:	125V	L1, N, G
6:	250V	L1, L2, G
14:	125/250V	L1, L2, N, G
15:	250V	L1, L2, L3, G
21:	250V/125V	L1, L2, L3, N, G

## How big can I go?

A common question from IT managers is, "I have a receptacle at my facility; what is the biggest UPS can I connect to it?" If you're looking at UPSs 6 kVA or lower, it's a pretty straight forward question to answer as shown below:

Local outlet		Typical largest UPS rating per outlet	
120V	5-15R		1500VA 120V
	5-20R		2200VA 120V
	L5-30R		3000VA 120V
208-240V	L6-20R		3000VA 208V
	L6-30R		6000VA 208V
208-240V	IEC C13		2200VA 230V
	IEC C19		3000VA 230V

### 1. Fixed

Smaller UPS models like the Eaton 9SX UPS provide a fixed set of output receptacles

### 2. Customized

UPS models like the Eaton 9355 can be customized with a variety of output receptacles

### 3. Hardwired

Large UPS models like the Eaton 93PM are hardwired to incoming utility power though some models leverage output receptacles

### 4. Additional receptacles

A FlexPDU is a basic function power distribution unit with a short power cord for easy, close mounting to a UPS. FlexPDUs are available with a variety of output receptacles, for connection to a wide range of equipment.

A HotSwap Maintenance Bypass enhances availability by providing service continuity and facilitates hot-swappable UPS battery replacement.

1



2



3



4



VA IS FOR WEAKLINGS.  
I MEASURE MY  
STRENGTH IN WATTS.



# The difference between VA and watts

**The engineering answer:** To correctly size a UPS, it's important to understand the relationship between watts and VA. However, we must first have a brief discussion about power terminology. Real power (measured in watts) is the portion of power flow that results in the consumption of energy. The energy consumed is related to the resistance in an electrical circuit. An example of consumed energy is the filament in a light bulb.

Reactive power (measured in VAR or volt-amps reactive) is the portion of power flow due to stored energy. Stored energy is related to the presence of inductance and/or capacitance in an electrical circuit. An example of stored energy is a charged flash bulb in a camera.

Apparent power (measured in VA or volt-amps) is a mathematical combination of real power and reactive power.

The geometric relationship between apparent power, reactive power and real power is illustrated in the power triangle below:

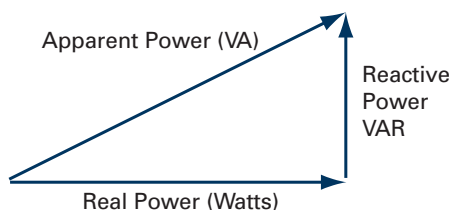

Mathematically, real power (watts) is related to apparent power (VA) using a numerical ratio referred to as the power factor (PF), which is expressed in decimal format and always carries a value between 0 and 1.0. For many newer types of IT equipment, such as computer servers, the typical PF is 0.9 or greater. For legacy personal computers (PCs), this value can be 0.60 – 0.75.

Using one of the following formulas, a calculation can be made to determine the missing quantity:

$$\text{Watts} = \text{VA} * \text{Power Factor} \text{ or } \text{VA} = \text{Watts} / \text{Power Factor}$$

Since many types of equipment are rated in watts, it's important to consider the PF when sizing a UPS. If you don't take PF into account, you may under size your UPS. As an example, a piece of equipment that's rated at 525 watts and has a power factor of 0.7 results in a 750 VA load.

$$750 \text{ VA} = 525 \text{ Watts} / 0.7 \text{ PF}$$

Sizing the UPS to operate at 75 percent capacity results in a UPS with a 1000 VA rating ( $750 \text{ VA} / 0.75 = 1000 \text{ VA}$ ).

**The answer for the rest of us:**

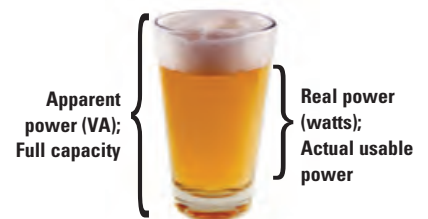

## Converting amps to VA

Single phase: Multiply amps by voltage (120 volts in the U.S.).  $10\text{A} \times 120\text{V} = 1200 \text{ VA}$ .  
Three phase: Amps x volts x 1.732 = VA.



View the Professor Wattson video on VA vs Watts:

[Switchon.eaton.com/power101](http://Switchon.eaton.com/power101)



# 9 ways BEER and UPSs are alike

Have you ever thought, “This crisp, cold beer really reminds me of my uninterruptible power supply?” Well, the beer you drink and the UPS power you use are arguably of equal importance, and more of a science than one may think. Here are 9 ways the beer in your glass matches the UPS in your server room.

## Best if used by [this date]

Beer expires, especially the hoppy kinds like an IPA. Make sure you don't leave the store with an expired beer. Do this once and you'll understand the importance of checking expiration dates on everything including your UPS batteries. It's beneficial to check and note the expiration date to ensure a replacement plan is in place.

## Power is in the watts

UPSs are typically rated in volt amperes (VA) but you should be looking at the wattage. For example, think of a 1 kVA UPS as a six pack. Would you rather have a six pack of 8 oz. or 12 oz. beers? Similarly, the wattage rating of a 1 kVA UPS typically ranges from 600 to 1000 watts. The higher the wattage rating, the more IT equipment you can power! For more information, check out our Professor Wattson video: [VA vs Watts](#).

## Pairing matters

To bring out its full potential, a UPS needs to be paired with the right equipment. Think racks, rack power distribution units (PDUs) and software. You'll be as pleased with your full solution as when you pair chocolate with a stout or a burger with a pale ale.

## Now trending

Though we advise to tread lightly when considering industry trends, a New England Style IPA is delicious! Some flash in the pan trends should be avoided, like Gose IMO—there's a reason that style died 70 years ago. But other trends like [lithium-ion batteries](#) can change the UPS landscape in your favor by lowering your total cost of ownership (TCO).

## Temperature is everything

There's a reason some cans have mountains that turn blue when cold . . . no one wants to drink that stuff warm! Similarly, heat can significantly diminish the performance, safety and lifetime of a battery. Both UPSs and beer perform better when stored and used at the proper temperature.

## How bold should you go

How full-flavored or feature-rich do you want to go? An online UPS, similar to an imperial chocolate coffee stout, has a lot to offer but could be too much depending on your needs. Some applications only call for a standby UPS the same way a cold, crisp light beer makes for a perfect after-mowing-your-yard treat.

## Redundancy

Make sure you have a backup. You may think you're only going to drink one, and then Billy stops by empty-handed and thirsty after the stores have closed. Redundancy is key! The surest way to increase your UPS availability is to incorporate a 2N or N+X redundant configuration for fault tolerance. And let's face it—a redundant environment can protect you from the Billy's of the world.

## Reviews are key

It's important to get the insider knowledge before you buy. Spiceworks.com and StorageReview.com are to IT pros as Untapped and NextGlass are to beer enthusiasts.

## Reduce, reuse, recycle

Whether a beer or a battery, don't forget to do your part to save the world. Both UPS batteries and cans/bottles can be recycled by Heritage Environmental Services. And for those empty cans and bottles, be sure to dispose in your nearest “blue bin.”





# UPS startup

## Self-startup

UPSs equipped with a standard input plug (units 1500 VA and below) that fits into standard wall sockets are very easy to install. Units 2000 VA and above require a different wall socket that may not already exist in the location where the UPS will be installed. In these cases, an electrician can install the proper wall socket, after which you should have little problem with UPS installation.

## Assisted startup

You may not feel comfortable installing electrical equipment—justifiably so. UPS installation deals with electrical power and batteries—both of which can be dangerous if not handled properly. In addition, UPS batteries can be very heavy and some units require a hardwired connection. As a result, UPS manufacturers usually offer a startup service for an additional fee. You can also hire a systems integrator, electrician or third-party service organization for UPS installation.

## Manufacturer-required startup

Many three-phase UPS models (typically >40 kVA) must be started up by the UPS manufacturer to ensure they're properly installed and calibrated. In general, electricians and contractors don't have the required in-depth knowledge of the UPS. Manufacturer-trained field technicians provide an overview of the equipment and a tutorial of how to operate the UPS.

Learn more about service options:

[Eaton.com/UPSservices](https://www.eaton.com/UPSservices)

I THINK I'LL GO WITH ASSISTED STARTUP.



# UPS vs. surge suppressor

Customers often ask us to explain the difference between a surge protector and an Uninterruptible Power Supply (UPS) — and which device is better suited for their environment.

The fact is that neither UPS nor surge protection devices (SPD) alone will provide complete protection for commercial systems. The most effective installation is ensured by utilizing a combination of both forms of power conditioning.

## Surge protector

Surge protectors (or suppressors) provide just that: a line of defense against surges, which are short-term high voltages above 110 percent of nominal. They are often associated with lightning strikes and utility switching, but in fact 80 percent of surges originate inside a facility. These occur due to electrical switching or other disturbances created by various devices within the building. Regardless of the source, the increased voltage from surges can damage the components of electrical systems such as computers, networks, and process control equipment.

Even if nothing is immediately destroyed, over time the increased strain can cause premature failure of expensive components. It's important to note that surge protection will not keep your equipment operational during a blackout, but damaging surges occur much more frequently than power outages. A properly designed backup power system should always incorporate a cascaded approach to applying surge protection (i.e. a two layered approach) working in conjunction with a UPS. The first surge unit, (upstream SPD) mitigates the brunt of the surge energy while the second unit (the UPS) reduces any remaining surge energy to an inconsequential level.

## Introducing the UPS

A UPS delivers second-level protection against surges; it should never be considered a primary surge protection device. It also continually regulates incoming voltage and provides an internal battery that allows connected equipment to continue running even if the power supply is cut. In order for your electronic devices to continue to function even if power is unavailable, you need a UPS, and often a backup generator.

So how do you apply these devices coherently? Surge protection should be installed on the utility side of your UPS, ideally on the bypass line. This provides the following modes of protection:

- Greatly extends the life of the surge protection components in your UPS
- Provides surge protection for your load when the UPS is off line for maintenance

Surge protection installed on the utility side of a UPS will also help protect the UPS. A dramatic surge event, such as a lightning strike can be associated with over 20 kV and 5 kA. The typical let through voltage of a surge device (UPS included) when subjected to this level of surge event would be roughly 2000V, which is still high enough to cause equipment damage. To eliminate this we install an upstream unit and allow the UPS to mitigate the effects of the remaining surge energy, i.e. driving the final let through voltage down to around 200V which is well below the point that would cause damage.

Additionally, it may be wise to install an SPD between the UPS output and the load distribution system. This is especially true if the load panel is located a long distance from the UPS. The more distance, the better likelihood that an internally generated surge could impact the load.

So which form of power protection is best suited for your environment? The answer is, both. Critical servers, workstations, PCs, POS and VoIP equipment, and other key business devices are protected by attaching a UPS, ensuring they are able to function in the event of a power outage and, if needed, shut down cleanly if power remains out for an extended period of time. Surge devices are required as well, to protect both critical equipment, and even the UPS itself.



Eaton Eclipse surge suppressors



# Decentralized or central UPS?

Is a single, larger UPS better, or is it best to have multiple, smaller UPSs? Naturally, the answer is that it depends on a number of factors. In a decentralized (also known as distributed) UPS configuration (see Figure 2), multiple UPSs support a handful of devices or perhaps only a single piece of equipment. Decentralized UPSs typically use plug and play connections and are usually less than or equal to six kVA. In a central UPS configuration (see Figure 1), a larger UPS supports multiple devices. A centralized UPS is typically hardwired into an electrical panelboard. The following tables include a number of factors to consider when making a decision between a decentralized and central UPS. In the end it's often best to simply go with the strategy that you are comfortable with.

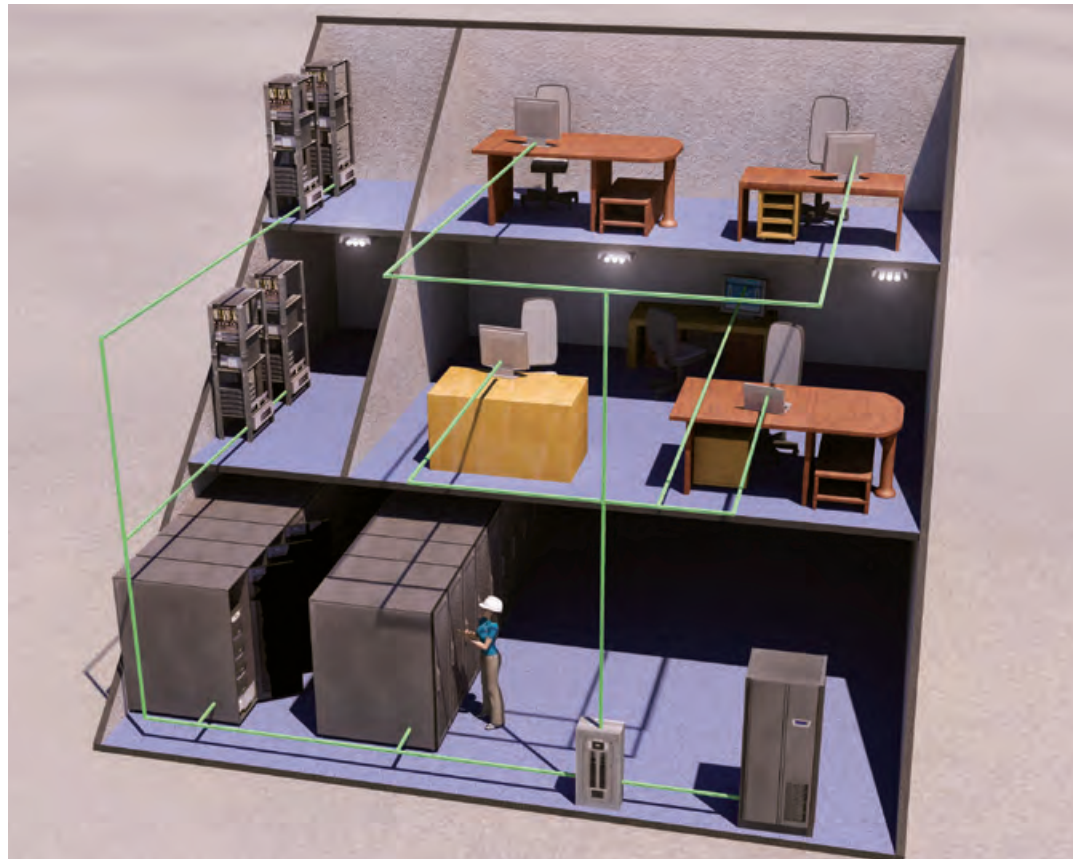
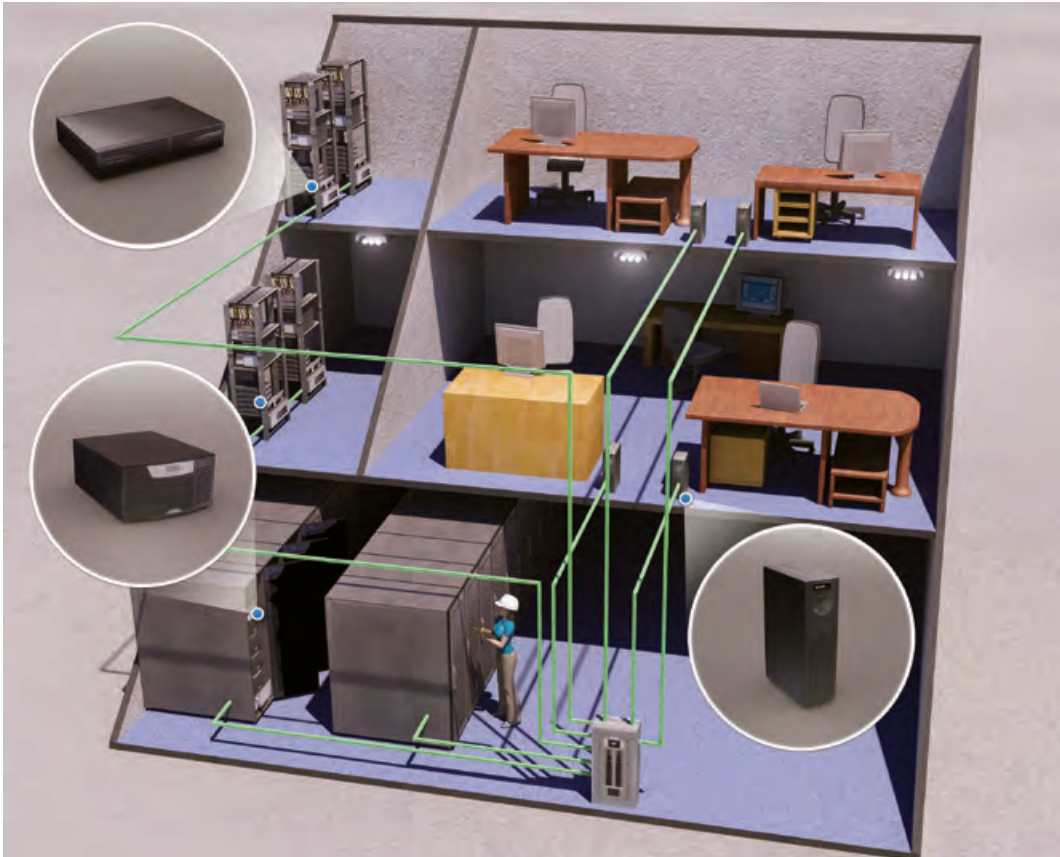

Figure 1

## Central UPS

Why you'd choose a central UPS solution	Why you wouldn't
Typically, the sales and service life of the UPS is longer.	A single UPS can mean single point of failure. You can overcome this concern with an N+1 or N+X UPS for redundancy.
A single UPS is easier to monitor, service and maintain than lots of smaller UPSs.	The single UPS may not be close physically to the equipment it will protect. A single electrical distribution panel may not feed all equipment.
Larger UPSs will be three-phase and/or 208V, 400V or 480V and often result in more efficient operation and lower operating costs.	There is no space for a large UPS.
A central UPS is often housed away from high traffic areas. As a result, it's less easily disrupted, accidentally damaged or maliciously interfered with.	A central UPS generally requires a trained service technician or electrician to service, maintain or install.
A central UPS can be located where cooling is more tightly controlled. Remember, heat is the enemy of the batteries inside a UPS.	A central UPS may incur higher installation and wiring costs.
Though a technician may need to replace the batteries, you only have to worry about a single UPS. A distributed UPS configuration may result in various models that require different batteries. Do you want to take the time to replace the batteries on five to 20 UPSs?	



### Combining the configurations

It's important to keep in mind that decentralized and centralized power protection deployment strategies aren't necessarily mutually exclusive. The two strategies can be used in combination to provide redundancy to mission-critical applications. For example, an entire facility may be protected by a large, centralized UPS, but a specific department such as a 24x7 call center may have decentralized UPSs as well to provide redundant protection and possibly extend runtime for call center equipment.

Figure 2

## Decentralized UPS

Why you'd choose a decentralized UPS onfiguration	Why you wouldn't
No rewiring is required. Use existing wall sockets. Easy plug and play installation. Can also be redeployed easily if IT systems are moved.	If a generator supports the building, smaller standby and line-interactive UPSs may not be able to function while it's running.
Requires lower capital outlay and installation costs. Fits within IT manager purchase limits. Generally don't need to approve a large capital expense. Will most likely not require additional installation costs from electrician.	No central panelboard exists or there's no room for the UPS.
You have no idea how much your company will grow and don't want to get locked into a particular UPS.	You don't want to monitor or service a bunch of UPS units. A decentralized design may require more time and focus to keep up with replacing batteries and maintaining multiple UPSs.
You already have a number of smaller UPS units that are fairly new and you don't want to discard them. (Most UPS manufacturers offer a trade-in program.)	You want a single UPS that can be shut down using emergency power off. Also, a decentralized design may not offer redundancy and other capabilities provided by a larger, central UPS.
Power conditioning is implemented at the point of use, which mitigates any electrical disturbances that may be coupled into the distribution wiring of a centralized system.	Adding redundancy, extended runtime or maintenance bypass functionality to multiple UPSs can be costly.
Diverse applications within a building may require varying levels of power protection and functionality. For example, extended runtime can be configured for specific applications, eliminating the need to add additional battery modules for less critical equipment.	Multiple audible alarms/alerts may be irritating.

# Make giving your UPS a health check-up top priority

In order to avoid an unexpected breakdown, your vehicle needs regular preventive maintenance, such as routine oil changes and tune-ups. Likewise, an annual visit to your physician's office helps identify any potential problems that could become health concerns. Ensuring the ongoing optimal performance of your UPS is much the same.

The following checklist will help you keep it in tip-top shape:

## 1. Make sure your batteries are in good health.

Batteries are the No. 1 cause of UPS failure, so it's wise to do the following:

- a. Note their age.** UPS batteries can last anywhere from 2-5 years, so if yours are 4 years old or older, you should probably begin planning a replacement.
- b. Run a UPS battery self-test.** Most network-class UPSs have the capability to run a quick self-check from the front menu.
- c. Check under the hood.** Remove the front bezel and make sure there are no signs of battery swelling or damage.
- d. Consider a preventive maintenance (PM) visit.** For customers with larger, centralized UPSs, consider having an electrician or factory-authorized technician test each individual battery, which provides a much more detailed picture of your system reliability.

## 2. Perform an early spring cleaning.

Clutter, dust and general disorganization can cause unwanted issues and decrease the reliability of your system, so be sure to:

- a. Check the air flow.** Make sure there is nothing blocking air-flow in your IT environment, since heat is one of the biggest reducers of battery life. You should have enough air flow to keep your UPS at room temperature (77°F is optimal).
- b. Dust!** Caked-on grime can damage fans and cause electronics board damage. A simple wipe down is often all you need. If you have a larger, centralized UPS, you may need to replace your air filter or make sure that it is clean.
- c. Air flow.** Make sure there isn't anything stacked on top of the UPS that could cause damage or block air-flow.

## 3. Verify UPS communication.

Properly configured communications ensure that IT managers can respond to alerts and take corrective actions, so:

- a. Run a test email.** If your UPS is equipped with a Network Interface Card (NIC), run a trial email. Sometimes changing email servers or domains can cause settings to be out-of-date.
- b. Check the software.** Make sure the UPS and NIC both have the most up-to-date versions.

## 4. Keep service information up-to-date.

Nothing can be more frustrating than finding out your UPS is no longer under warranty after it fails. Be sure to:

- a. Double-check your service contract.** Review your coverage and consider storing contract information in one place, either physically or electronically.
- b. Register your product.** If you do not have a service contract, at least make sure your UPS is registered with the manufacturer. This helps you stay informed on updates, and allows the manufacturer to respond quickly if an issue does arise.

These simple steps will go a long way toward ensuring the ongoing reliability of your UPS, and in turn, the critical equipment and data it is protecting.

I HAVE A QUESTION.  
WHICH DESERVES  
NEW LIFE MORE? YOUR  
IT INFRASTRUCTURE  
OR ME?



# What is three-phase power?

I LIKE THE RHYTHM OF THREE-PHASE POWER.

Three-phase power, the most efficient way to distribute power over long distances, allows for large industrial equipment to operate more efficiently. It's characterized by three single-phase waves that are offset in their phase angle by 120 degrees, or one-third of the sine wave period as illustrated in Figure 1.

Three-phase voltage can be measured from each phase to neutral or from one phase to any other. The voltage relation between phase-to-neutral and phase-to-phase is a factor of the square root of three (e.g., 120V versus 208V).

Conversely, single-phase power is distributed through common household outlets to power everyday equipment such as laptops, lighting and televisions. When looking at an oscilloscope image of the voltage coming out of a single-phase outlet as illustrated in Figure 2, there's only a single wave. Single-phase power is obtained by simply using only one phase of a three-phase system. Its root mean square (RMS) voltage is 120V (for North America) and it oscillates between its peaks of  $\pm 170V$  at 60 Hz (or 60 times a second).

## Single-phase or three-phase power?

Single-phase advantages	Three-phase advantages
The standard for locations where three-phase power is unavailable.	Can help balance the loads on the utility power of the building.
Usually easier to distribute power in low kVA and low-density applications.	Usually easier to distribute power in higher kVA and high-density rack applications.
	Allows for smaller amperage electrical devices within the solution (breakers, wiring, panels, etc.).

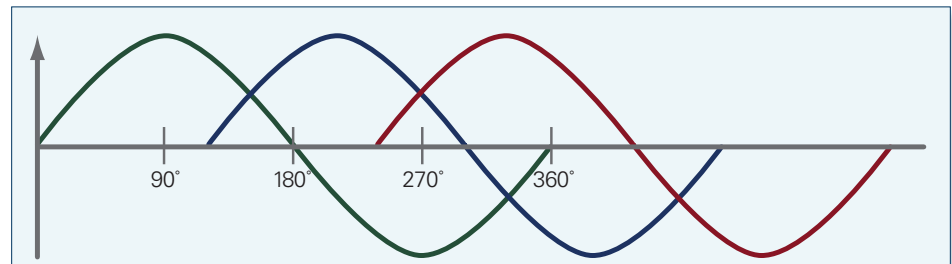

Figure 1. Three-phase power

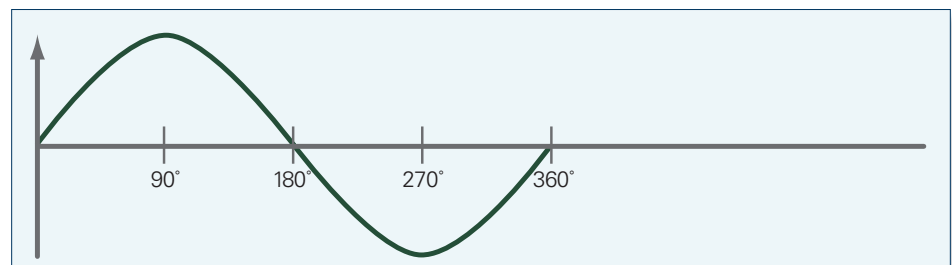

Figure 2. Single-phase power



# Increase server energy efficiencies by using high-voltage power supplies and 208V UPSs

Maximizing energy efficiencies in today's data centers has become an important factor in saving costs and reducing an organization's carbon footprint. While there are new energy-saving tools and technologies being introduced every day, understanding existing methods and systems can bring immediate efficiencies and savings, often without an additional investment.

One such method is to operate equipment at high-line voltage and use 208V UPSs, which maximizes energy efficiency and uptime, and saves money. IT devices equipped with a C14 plug are capable of running on high voltage, which can dramatically increase efficiency.

Even small increases in UPS efficiency can quickly translate into tens of thousands of dollars in savings. For example, assuming a utility rate of 10 cents per kWh, a 60 kW N+1 redundant configuration would save more than \$30,000 over five years. High UPS efficiency also extends battery runtimes and produces cooler operating conditions, resulting in lower utility bills.

At first glance, high-voltage input power seems counter-intuitive when thinking about energy savings. However, in the real world, power supplies operate more efficiently at high voltage. The typical server switch-mode power supply has an efficiency rating between 65 and 80 percent, with some special-purpose products able to reach 90 percent efficiency. Lower voltage causes the power supply to operate at the lower end of this range.

When operating at 208 volts, a 1 to 2 percent difference in efficiency can be experienced for a 1000W power supply, depending on the load level. When the loss in the power distribution transformer (PDU) needed to get to the 120V is added, there's an additional 1.5 to 2 percent savings. Factor in cooling efficiencies and the savings can add up to between 4 and 8 percent, which translates to about \$70 per power supply. When multiplied by the number of power supplies in the server rack, the savings certainly justifies making the switch to 208 volts, especially when expanding or moving into a new location.



Remove the standard 5-15P/C13 power cord that shipped with your IT equipment and replace it with one of the C13/C14 jumper cables that shipped with your UPS. Your IT equipment is now operating at 208V, running more efficiently and saving you money.

**HIGH VOLTAGE  
MAKES ME SIZZLE!**



## DID YOU KNOW SWITCHING TO HIGH VOLTAGE IS EASY?

One of the main reasons that U.S. customers have been reluctant to switch to high voltage is that high voltage UPSs are typically fitted with IEC outlets (or even inlets) and customers don't know how to connect them to IT equipment with a traditional NEMA plug.

### Don't shy from making the switch over a silly plug problem.

All IT power supplies come with a detachable input cord with a NEMA plug on one side and an IEC plug on the other. By simply changing the standard NEMA/C13 power cord to an IEC C13/C14 power cord, these additional IT equipment efficiencies can be captured. IEC cables are fully UL-listed and are the standard method of connection in large mission-critical data centers across the U.S.

# Worldwide voltage map

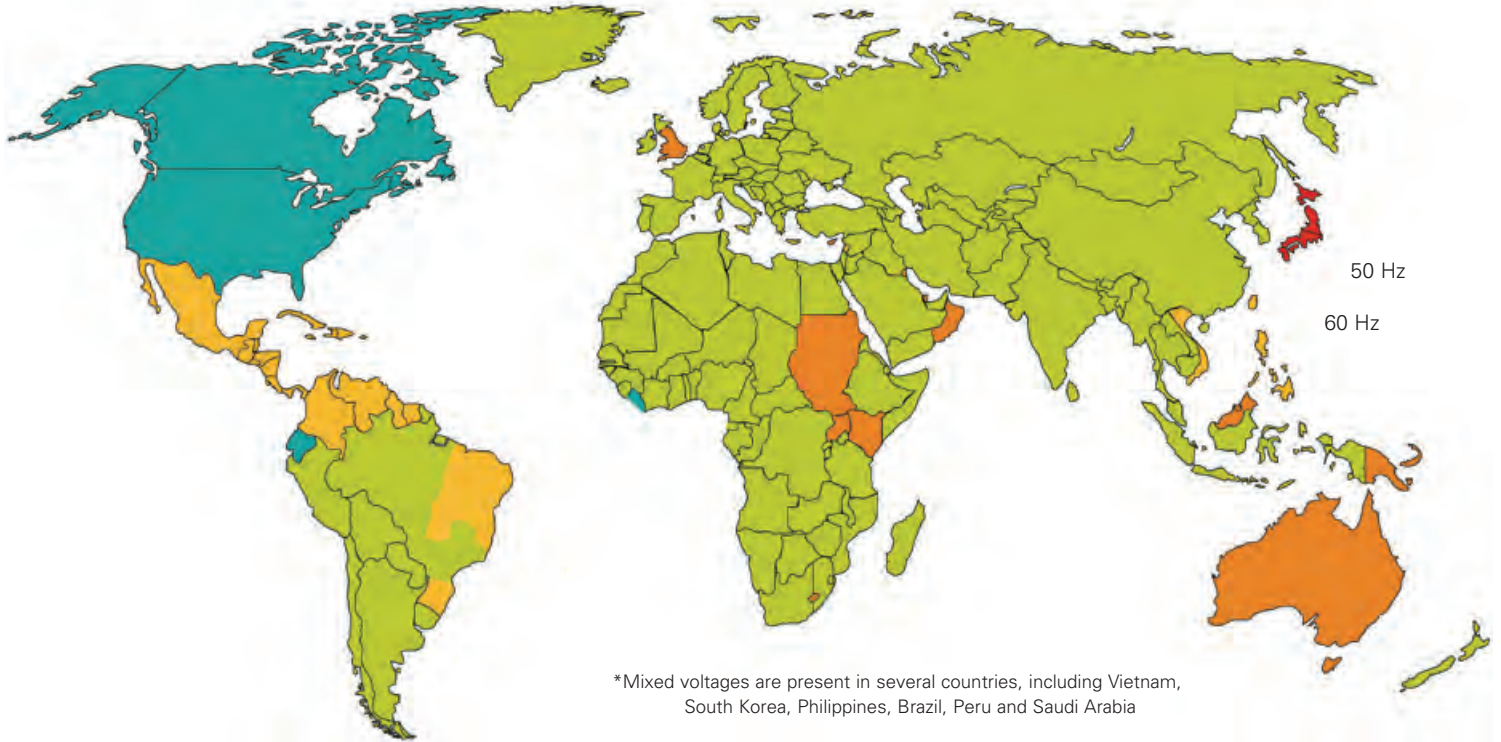

## Single-phase voltages\*

- 110-127V; 60 Hz (also 208V; 60 Hz)
- 110-127V; 60 Hz
- 100V
- 220/230V; 50 Hz
- 240V; 50 Hz

I ROAMED THE  
WORLD BEFORE  
THERE WERE  
VOLTAGES.



# Worldwide voltages

Country	Single-phase voltage (V)	Three-phase voltage (V)	Frequency (Hz)	Country	Single-phase voltage (V)	Three-phase voltage (V)	Frequency (Hz)	Country	Single-phase voltage (V)	Three-phase voltage (V)	Frequency (Hz)
Afghanistan	220	380	50	Gambia	220	400	50	New Zealand	230	415	50
Albania	230	400	50	Gaza	230	400	50	Nicaragua	120	208	60
Algeria	127/220	400	50	Georgia	220	380	50	Niger	220	380	50
American Samoa	120/240	208	60	Germany	220-230	400	50	Nigeria	230	400	50
Andorra	230	400	50	Ghana	220	400	50	Northern Ireland	240	400	50
Angola	220	380	50	Gibraltar	240	400	50	Norway	220-230	400	50
Antigua	230	400	60	Greece	220-230	400	50	Okinawa	110-120	200/230	60
Armenia	230	380	50	Greenland	220	400	50	Oman	240	415	50
Argentina	220	380	50	Grenada	230	400	50	Pakistan	230	400	50
Aruba	115/127	220	60	Guadeloupe	220	400	50	Palau	120	208	60
Australia	240	415	50	Guam	110-120	190	60	Panama	110-120	190	60
Austria	220-230	400	50	Guatemala	120	208	60	Papua New Guinea	240	415	50
Azerbaijan	220	380	50	Guinea	220	208	50	Paraguay	220	380	50
Azores (Portugal)	220	400	50	Guinea-Bissau	220	380	50	Peru	110/220	220	50/60
Bahamas	120	208	60	Guyana	110	190	50/60	Philippines	115	380	60
Bahrain	220	400	50	Haiti	110-120	190	50/60	Poland	240	400	50
Balearic Islands	230	400	50	Honduras	110	190	60	Portugal	220	400	50
Bangladesh	220	380	50	Hong Kong	200	380	50	Puerto Rico	220-230	208	50
Barbados	115	200	50	Hungary	220	400	50	Qatar	240	415	50
Belarus	220	380	50	Iceland	220	400	50	Réunion Island	230	400	50
Belgium	220-230	400	50	India	220-250	400	50	Romania	220	400	50
Belize	110	190/380	60	Indonesia	220	400	50	Russia	220	400	50
Benin	220	380	50	Iran	220	400	50	Rwanda	220	400	50
Bermuda	120	208	60	Iraq	220	400	50	Saudi Arabia	127/220	190/380	50/60
Bhutan	230	400	50	Ireland	220	400	50	Scotland	220	400	50
Bolivia	110-115/220	400	50	Isle of Man	240	400	50	Senegal	220	400	50
Bosnia-Herzegovina	220	400	50	Israel	230	400	50	Serbia	230	400	50
Botswana	220	400	50	Italy	220-230	400	50	Seychelles	240	240	50
Brazil	110-127/220	220/380/440	60	Ivory Coast	220	380	50	Sierra Leone	230	400	50
Brunei	240	415	50	Jamaica	110	190	50	Singapore	230	400	50
Bulgaria	220	400	50	Japan	100	200	50/60	Slovakia	220	400	50
Burkina Faso	220	380	50	Jordan	220	400	50	Slovenia	230	400	50
Burundi	220	380	50	Kazakhstan	220	380	50	Somalia	110/220	380	50
Cambodia	120/220	400	50	Kenya	240	415	50	South Africa	220-230	400	50
Cameroon	220-230	380	50	Korea, South	220	380	50/60	Spain	220-230	400	50
Canada	120	208/240/600	60	Kuwait	240	415	50	Sri Lanka	230	400	50
Canary Islands (Spain)	220	400	50	Kyrgyzstan	220	380	50	St. Kitts & Nevis	230	400	60
Cape Verde	220	400	50	Laos	220	400	50	St. Lucia	240	400	50
Cayman Islands	120	208	60	Latvia	220	400	50	St. Vincent	230	400	50
Central African Republic	220	380	50	Lebanon	110-220	400	50	Sudan	240	400	50
Chad	220	380	50	Lesotho	240	380	50	Surinam	115	220	60
Channel Islands	240	400	50	Liberia	120	208	60	Swaziland	230	400	50
Chile	220	380	50	Libya	127-230	220/400	50	Sweden	220-230	400	50
China	220	380	50	Liechtenstein	220	400	50	Switzerland	220-230	400	50
Colombia	110-220	440	60	Lithuania	220	400	50	Syria	220	380	50
Congo	220	400	50	Luxembourg	220-230	400	50	Tahiti	220	380	50
Congo, Dem. Rep. of (formerly Zaire)	220	380	50	Macau	220	380	50	Taiwan	110	190	60
Cook Islands	240	415	50	Macedonia	230	400	50	Tajikistan	220	380	50
Costa Rica	120	240	60	Madagascar	220	220/380	50	Tanzania	230	400	50
Croatia	220	400	50	Madeira (Portugal)	220	400	50	Thailand	220/230	380	50
Cuba	120	190	60	Malawi	230	400	50	Togo	220	380	50
Cyprus	240	400	50	Malaysia	240	415	50	Tonga	115	415	60
Czech Republic	220	400	50	Maldives	230	400	50	Trinidad & Tobago	115/23	200	60
Denmark	220-230	400	50	Mali	220	380	50	Tunisia	220	400	50
Djibouti	220	380	50	Malta	240	400	50	Turkey	220	400	50
Dominica	230	400	50	Martinique	220	380	60	Turkmenistan	220	380	50
Dominican Republic	110	120/208/227/480	60	Mauritania	220	220	50	Uganda	240	415	50
Ecuador	120	190	60	Mauritius	230	400	50	Ukraine	220	380	50
Egypt	220	380	50	Mexico	127	220/480	50	United Arab Emirates	220/230	415	50
El Salvador	115	200	60	Moldova	220	380	50	United Kingdom	240	400	50
England	240	400	50	Monaco	220	400	50	United States	120	277/480	60
Estonia	220	400	50	Mongolia	220	400	50	Uruguay	220	220	50
Ethiopia	220	380	50	Montserrat	230	400	60	Uzbekistan	220	380	50
Faeroe Islands	230	400	50	Morocco	220	380	50	Venezuela	120	240	60
Falkland Islands	240	415	50	Mozambique	220	380	50	Vietnam	120/220	380	50
Fiji	240	415	50	Myanmar	230	400	50	Virgin Islands	120	190	60
Finland	220-230	400	50	Namibia	220-250	380	50	Wales	220	400	50
France	220-230	400	50	Nauru	240	415	50	Western Samoa	230	400	50
French Guiana	220	380	50	Nepal	220	400	50	Yemen	220	400	50
Gabon	220	380	50	Netherlands Antilles	120-127/220	220/380	50/60	Zambia	220	400	50
				Netherlands	220-230	400	50	Zimbabwe	220	415	50
				New Caledonia	220	380	50				

# The nine power problems

AH, MORE  
MINIONS FOR  
MY EVIL PLAN!



In an ideal world, your wall socket would provide an infinite stream of perfect power, at constant voltage and cycling exactly the same number of times per second. Don't count on it.

Power Problem		Definition
1 Power failure		When a superhero loses his ability to fly or a <b>total loss of utility power.</b>
2 Power sag		Post-lunch sleepiness or <b>short-term low voltage.</b>
3 Power surge (spike)		Rush of energy following a double shot of espresso or <b>short-term high voltage more than 110 percent of normal.</b>
4 Under-voltage (brownout)		When your amp's too wimpy to handle the bass line or <b>reduced line voltage for an extended period of a few minutes to a few days. Often happens during the summer months when everyone is cranking up their air conditioners.</b>
5 Over-voltage		Inhuman cheerfulness exuded by aerobics instructors or <b>increased line voltage for an extended period of a few minutes to a few days.</b>
6 Electrical line noise		Excuse you use to get off the phone quickly or a <b>high power frequency power wave caused by radio frequency interference (RFI) or electromagnetic interference (EMI).</b>
7 Frequency variation		Fluctuation in how often you do laundry from week to week or a <b>loss of stability in the power supply's normal frequency of 50 or 60 Hz.</b>
8 Switching transient		Breaking up with your significant other only to get back together every six months or <b>instantaneous under-voltage in the range of nanoseconds.</b>
9 Harmonic distortion		"Music" blaring from your nephew's headphones or <b>the distortion of the normal power wave, generally transmitted by unequal loads.</b>



# UPS topologies

There are several different UPS topologies that provide varying degrees of protection. Selecting the best fit depends on several factors, including the level of reliability and availability desired, the type of equipment being protected and the application/environment. While all four of the most common UPS topologies outlined below meet the input voltage requirements for IT equipment, there are key differences in how the result is achieved, as well as the frequency and duration of demands on the battery.

**Standby UPSs** allow equipment to run off utility power until the UPS detects a problem, at which point it switches to battery power to protect against sags, surges or outages. This topology is best suited for applications requiring simple backup such as small office/home office and point-of-sale equipment.

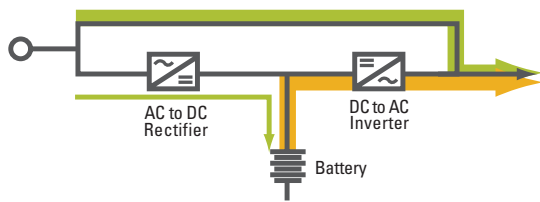

**Line-interactive UPSs** actively regulate voltage either by boosting or decreasing utility power as necessary before allowing it to pass to the protected equipment or by resorting to battery power. Line-interactive models are ideal for applications where protection from power anomalies is required, but the utility power is relatively clean. MDF and IDF communication closets, non-centralized server and network rooms, and general IT enclosures are ideally suited for this topology.

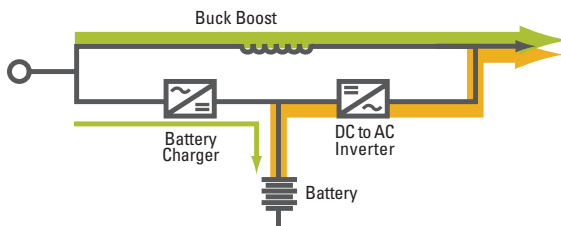

█ Normal Operation  
█ Battery Power

**Online UPSs** provide the highest level of protection by isolating equipment from raw utility power—converting power from AC to DC and back to AC. Unlike other topologies, double conversion provides zero transfer time to battery for sensitive equipment. This topology is best applied to mission-critical equipment and locations where power generally is poor.

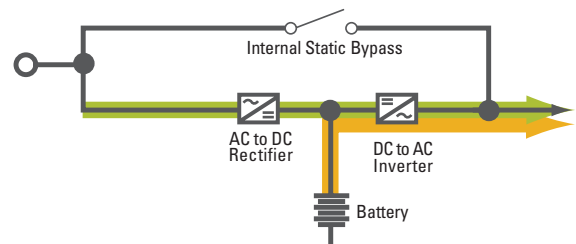

**Ferroresonant UPSs** operate similarly to line-interactive models with the exception that a ferroresonant transformer is used to condition the output and hold energy long enough to cover the time between switching from line power to battery power which effectively means a no-break transfer. Many ferroresonant UPSs are 82-88 percent efficient and offer excellent isolation. Although no longer the dominant type of UPS, these robust units are still used in industrial settings such as the oil and gas, petrochemical, chemical, utility and heavy industry markets.

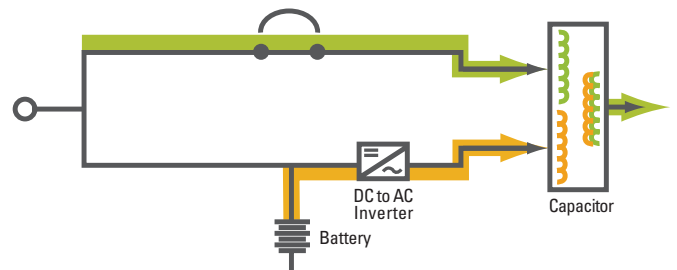

# UPS battery overview

It's well known that the battery is the most vulnerable part of a UPS. In fact, battery failure is a leading cause of load loss. Understanding how to properly maintain and manage UPS batteries can extend their service life and help prevent costly downtime.

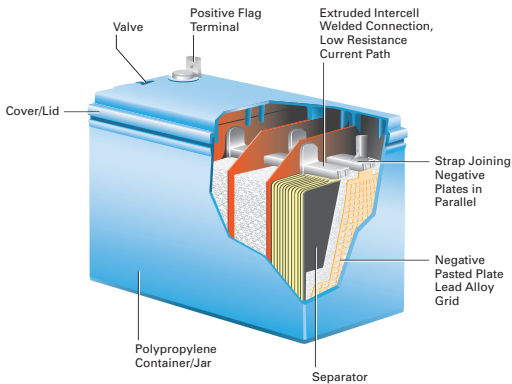

Figure 2. Internal and external components of a valve-regulated lead acid (VRLA) battery.

Valve-regulated lead acid (VRLA) batteries, also known as sealed or maintenance free are most commonly used in UPSs. VRLA batteries are sealed, usually within polypropylene plastic, which offers the advantage of not containing any sloshing liquid that might leak or drip. Because water can't be added to VRLA batteries, recombination of water is critical to their life and health, and any factor that increases the rate of evaporation or water loss—such as temperature or heat from the charging current—reduces battery life.



Figure 1. VRLA batteries are frequently used in UPS or other high-rate applications.

## Frequently asked questions

### Questions

### Answers

**What is the “end of useful life”?**

The IEEE defines “end of useful life” for a UPS battery as the point when it can no longer supply 80 percent of its rated capacity in ampere-hours. When your battery reaches 80 percent of its rated capacity, the aging process accelerates and the battery should be replaced.

**Is there any difference between the batteries used by smaller UPSs, from 250 VA to 3 kVA, and the ones used by larger UPSs?**

While basic battery technology and the risks to battery life remain the same regardless of UPS size, there are some inherent differences between large and small applications. Smaller UPSs typically have only one VRLA battery that supports the load and needs maintenance. As systems get larger, increasing battery capacity to support the load gets more complicated. Larger systems may require multiple strings of batteries, introducing complexity to battery maintenance and support. Individual batteries must be monitored to prevent a single bad battery from taking down an entire string, and putting the load at risk. Also, as systems get larger, wet-cell batteries become much more common.

**My UPS has been in storage for over a year. Are the batteries still good?**

As batteries sit unused, with no charging regimen, their life will decrease. Due to the self-discharge characteristics of lead-acid batteries, it is imperative that they be charged after every six to 10 months of storage. Otherwise, permanent loss of capacity will occur between 18 and 30 months. To prolong shelf life without charging, store batteries at 10°C (50°F) or less.

**What is the difference between hot-swappable and user-replaceable batteries?**

Hot-swappable batteries can be changed out while the UPS is running. User-replaceable batteries are usually found in smaller UPSs and require no special tools or training to replace. Batteries can be both hot-swappable and user-replaceable.



Figure 3. UPS models like the Eaton 9130 feature hot-swappable batteries for maximum uptime.

**How is battery runtime affected if I reduce the load on the UPS?**

The battery runtime will increase if the load is reduced. As a general rule, if you reduce the load by half, you triple the runtime.

**If I add more batteries to a UPS, can I add more load?**

Adding more batteries to a UPS can increase the battery runtime to support the load. However, adding more batteries to the UPS doesn't increase the UPS capacity. Be sure your UPS is adequately sized for your load and then add batteries to fit your runtime needs.



Figure 4. Adding extended battery modules increases runtime but doesn't increase the power rating or capacity of the UPS.

Questions	Answers
<b>Can I mix batteries by type or age?</b>	No, it's important that you never mix batteries by manufacturer, type or age. Always remove and replace all the batteries in the device at the same time, and follow the manufacturer's recommendations to which to use. Remember to read the warnings and small print before installing.
<b>If my UPS is in storage, how often should I charge the batteries?</b>	The standard lifespan for VRLA batteries is three to five years. However, expected life can vary greatly due to environmental conditions, number of discharge cycles, and adequate maintenance. Have a regular schedule of battery maintenance and monitoring to ensure you know when your batteries are reaching their end-of-life. The typical life of an Eaton UPS with ABM technology is 50 percent longer than with standard models.
<b>What is the average lifespan of UPS batteries?</b>	The standard lifespan for VRLA batteries is three to five years. However, expected life can vary greatly due to environmental conditions, number of discharge cycles, and adequate maintenance. Have a regular schedule of battery maintenance and monitoring to ensure you know when your batteries are reaching their end-of-life. The typical life of an Eaton UPS with ABM technology is 50 percent longer than with standard models.
<b>Why are batteries disconnected on small, single-phase UPSs when they're shipped?</b>	This is done to ensure they're in compliance with Department of Transportation regulations.
<b>Does the UPS need to have a load on it to charge its batteries?</b>	The UPS should have a minimum of 10 percent load to charge its batteries. Once connected to a standard supply of electricity (via input plug or hardwiring), your UPS should charge its batteries regardless of how much load, is attached to it.
<b>How can you be sure UPS batteries are in good condition and ensure they have maximum holdover in the event of a power failure? What preventive maintenance procedures should be done and how often?</b>	The batteries used in the UPS and associated battery modules and cabinets are sealed, lead-acid batteries often referred to as maintenance-free. While these types of batteries are sealed and you don't need to check their fluid level, they do require some attention to assure proper operation. You should inspect the UPS a minimum of once per year by initiating a self-test.
<b>How long does it take for the UPS batteries to recharge?</b>	On average, it takes 10 times the discharge time for the UPS batteries to recover. (A 30-minute battery discharge requires about 300 minutes to recharge.) After each power outage, the recharge process begins immediately. It's important to note that the load is fully protected while the batteries are recharging, but if the batteries are needed during that time, the holdover time available will be less than it would have been if the batteries were fully charged.
<b>What are the risks associated with a lack of battery maintenance?</b>	The primary risks of improperly maintaining batteries are load loss, fire, property damage and personal injury.
<b>What is thermal runaway?</b>	Thermal runaway occurs when the heat generated in a lead-acid cell exceeds its ability to dissipate it, which can lead to an explosion, especially in sealed cells. The heat generated in the cell may occur without any warning signs and may be caused by overcharging, excessive charging, internal physical damage, internal short circuit or a hot environment.
<b>Why do batteries fail?</b>	Batteries can fail for a multitude of reasons, but common reasons are: <ul style="list-style-type: none"> <li>• High or uneven temperatures</li> <li>• Loss of electrolyte due to drying out or a damaged case</li> <li>• Inaccurate float charge voltage</li> <li>• Lack of maintenance, aging</li> <li>• Loose inter-cell links or connections</li> </ul>
<b>How is battery performance generally measured?</b>	Batteries are generally rated for 100+ discharges and recharges, but many show a marked decline in charging capacity after as few as 10 discharges. The lower the charge the battery can accept, the less runtime it can deliver. Look for batteries with a high-rate design that sustains stable performance for a long service term.



**View the Professor Wattson video on batteries:**

[Switchon.eaton.com/power101](http://Switchon.eaton.com/power101)



# Factors affecting battery life

All UPS batteries have a limited service life, regardless of how or where the UPS is deployed. While determining battery life can be tricky, there are four primary factors that contribute to a battery's overall lifespan.

## 1. Ambient temperature

The rated capacity of a lead acid battery is based on an ambient temperature of 77°F. It's important to know that any variation from this operating temperature can alter the battery's performance and shorten its life. To help determine battery life in relation to temperature, remember for every 15°F average annual temperature above 77°F, the life of the battery is reduced by 50 percent. Ambient temperatures below 77°F may reduce the battery backup time, similar to a car battery on a cold morning.

## 2. Battery chemistry

Positive grid corrosion has been the most common end-of-life factor for UPS batteries, which is a result of the normal aging process due to UPS battery chemistry and involves the gradual breakdown of the inner segments of the positive grid within the battery.

## 3. Cycling

During a utility power failure, a UPS operates on battery power. Once utility power is restored, or a switch to generator power is complete, the battery is recharged for future use. This is called a discharge cycle. At installation, the battery is at 100 percent of rated capacity. Each discharge and subsequent recharge reduces its relative capacity by a small percentage. The length and quantity of discharge cycles determine the reduction in battery capacity.

A good analogy is a loaf of bread. It can be sliced into many thin slices, or a few thicker slices. You still have the same amount of bread either way. Similarly, a UPS battery's capacity can be used up over a large number of short cycles or fewer cycles of longer duration.

Lead-acid chemistry, like what's used in rechargeable batteries, can only undergo a certain number of discharge/recharge cycles before the chemistry is depleted. Once the chemistry is depleted, the cells fail and the battery must be replaced.

## 4. Maintenance

Battery service and maintenance are critical to UPS reliability. A gradual decrease in battery life can be monitored and evaluated through voltage checks, load testing or monitoring. Periodic preventive maintenance extends battery string life by preventing loose connections, removing corrosion and identifying bad batteries before they can affect the rest of the string.

Even though sealed batteries are sometimes referred to as maintenance-free, they still require scheduled maintenance and service. Maintenance-free simply refers to the fact that they don't require added water.

Without regular maintenance, a UPS battery can experience heat-generating resistance at the terminals, improper loading, reduced protection and premature failure.

## 5. Shelf life, storage and acceptance testing

It's important to ensure that batteries are properly stored prior to being installed and placed into service in order to improve service life expectations and reliability. Storage facilities should be climate controlled with proper ventilation capabilities so batteries can be kept cool and dry. Failure to comply with proper storage can lead to shortened runtimes and reduced capacity.

All battery manufacturers have shelf life and storage parameters.

### TIP

In terms of time, a good rule of thumb is no more than six months of storage in a properly designed storage facility.



### TIP

With proper maintenance, the end of battery life can be accurately estimated and replacements scheduled without unexpected downtime or loss of backup power.



To validate runtime and capacity expectations, an acceptance test should be performed. The acceptance test will be able to determine if there are any flaws within the manufacturing process, improper storage or perhaps even hidden damage as a result of shipping and handling. This test might be the most important procedure any operator can have performed to ensure reliability of the battery systems.



**BATTERIES ARE HEAVY. THEY GET ME PUMPED UP.**

**For additional information on UPS batteries, to use the Eaton battery replacement selector, or to request a free copy of Eaton's battery handbook, visit:**

[Eaton.com/UPSbatteries](http://Eaton.com/UPSbatteries)



# Transform your power infrastructure with lithium-ion batteries

While valve regulated lead acid (VRLA) batteries have long been the industry choice for UPS, new lithium-ion batteries offer additional benefits while still meeting required backup runtime.

Lithium-ion batteries are poised to become the preferred choice for UPSs in IT applications. The batteries last longer and recharge faster, saving time, saving money and reducing risk throughout the lifecycle of the UPS. The benefits of this lightweight solution will justify the upfront investment.

## Not all batteries are created equal

There are many different types of lithium-ion battery chemistries available in the market. Eaton utilizes a combination of lithium phosphate that creates a stable and safe battery for UPS applications. This type of chemistry does not create oxygen as an off-put should there be a thermal event, eliminating the harsh igniting potential of some lithium-ion battery chemistries.

Safety benefits	Installation benefits	Performance benefits
<ul style="list-style-type: none"> <li>Lithium phosphate battery chemistry is stable and safe</li> <li>Battery management system (BMS) actively monitors temperature and charge cycles</li> <li>Common vendor for battery and BMS improves integration and safety</li> </ul>	<ul style="list-style-type: none"> <li>Save money on battery replacement costs</li> <li>40% weight reduction eases installation</li> <li>Shift your refresh cycle to be in line with your IT equipment</li> </ul>	<ul style="list-style-type: none"> <li>2-3X longer life allows you to set it and forget it</li> <li>6X faster charge improves recovery</li> <li>BMS provides up-to-date insight into battery performance</li> </ul>



Eaton 5P UPS with lithium-ion battery

## By the numbers: 5P 1U 1500 VA UPS

Characteristic	VRLA battery	Lithium-ion battery	Lithium-ion benefit
Battery life span	3-4 years	8 years	2-3X longer life
Recharge time (from 0% to 90% runtime capacity)	24 hours	4 hours	6X faster recovery
Battery weight	19 lb.	11 lb.	40% lighter weight
Battery replacement cost	\$600*	\$0	\$0 OpEx expenditure
Warranty	3 years	5 years	2X warranty coverage

\*Battery and labor cost for two replacements

# UPS software overview

EVEN I COULD USE A LITTLE MORE VISIBILITY TO NETWORK POWER CONDITIONS.



Operating UPS power without power management software is like driving in the rain without windshield wipers—you may be protected from the downpour, but your visibility is hindered. Together, a UPS solution and monitoring and management software is the perfect complement.

Most businesses today are leveraging some level of virtualization for network, storage, application or servers. Read the top two criteria to consider when choosing software that safeguards your equipment and expands the capabilities of your virtual environment.

## 1. Establish which software integrates with your virtualization platform

Power management software that integrates with the leading virtualization platforms such as VMware and Microsoft makes monitoring and management seamless and saves you time.

## 2. Identify what you want to accomplish with the software

- Do you want it to plug directly into your virtual dashboard?
- Do you want to initiate planned migrations?
- Do you want to perform load shedding?
- Do you want to remotely shut down a host in a cluster without needing to install shutdown agents on each host or each virtual machine?

Once you've selected a power management software solution that seamlessly integrates into your major virtualization platform and meets the needs of your environment, you will be able to enjoy a number of advantages.

### Cost savings

- Less hardware, power used, cooling, and management
- Increased productivity—no need to recreate your work-in-progress

### Business continuity and disaster recovery (BCDR)

- Data integrity and graceful shutdown in the event of an extended outage
- Initiate planned migrations to a cloud recovery site
- Extended runtime to critical applications with load shedding

### Management ease

- A global view across the network on one screen—often from any PC with an Internet browsers A complete log of events and UPS utility data.
- Centralized alarms
- Organized data by customized views
- Event logs for preventive maintenance of the entire installed equipment base

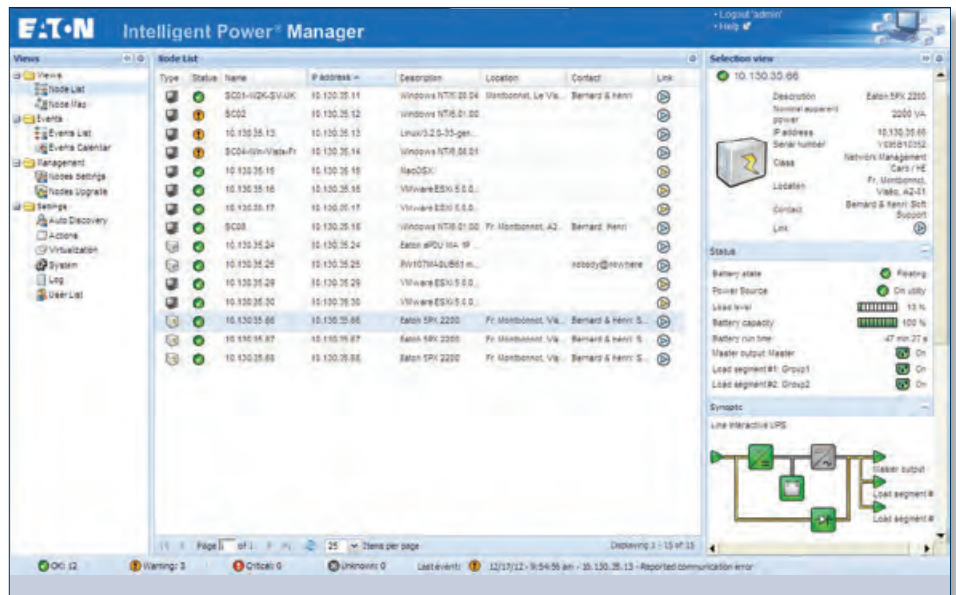

Figure 1. Eaton's Intelligent Power Manager (IPM) facilitates easy and versatile remote monitoring and management of multiple devices, keeping you apprised of power and environmental conditions.

View the Professor Wattson video on virtualization:

[Switchon.eaton.com/power101](http://Switchon.eaton.com/power101)

# Typical PDU configurations with UPS models

## Recommendations for improved reliability

In traditional power designs, you may have one UPS supporting your servers, switches and storage devices. In this type of environment, you are prone to having to shut down your equipment during a power failure, UPS maintenance or UPS replacement.

### Traditional installation

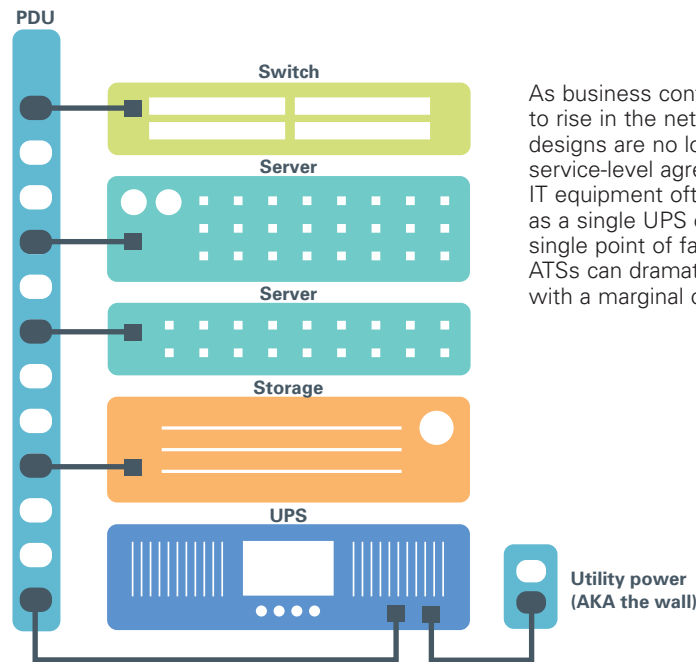

As business continuity requirements continue to rise in the network closet, traditional power designs are no longer adequate to meet IT service-level agreements. However, single-corded IT equipment often complicates system design, as a single UPS or rack PDU may represent a single point of failure. Maintenance bypass or ATs can dramatically improve system reliability with a marginal cost impact.

### Maintenance bypass

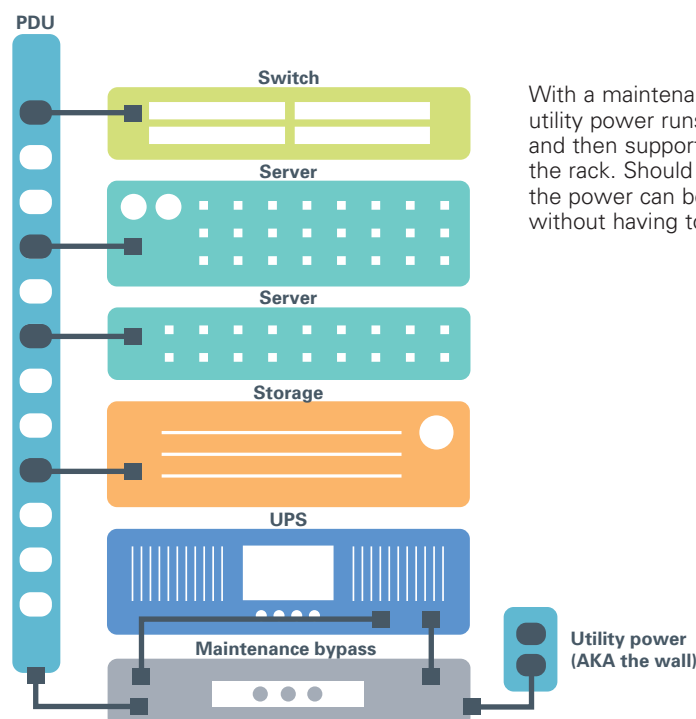

With a maintenance bypass (MBP) for example, utility power runs through the MBP via the UPS and then supports the rest of the equipment in the rack. Should the UPS need to be replaced, the power can be switched away from the UPS without having to shut down your equipment.

## Eaton ATS models:



- 1 Graphical LCD (available on the 15- and 20-amp models) signifies which source is being output (30-amp models have a static display for identifying the source)
- 2 Test button can be used to manually force transfer
- 3 Network card supports IPv6 and provides remote monitoring capabilities via web browser or SNMP

Remotely monitor alerts, provide redundant power and keep mission critical applications running with this reliable and easy-to-use solution. [Eaton.com/eATS](http://Eaton.com/eATS).

### Dual feed, dual UPS

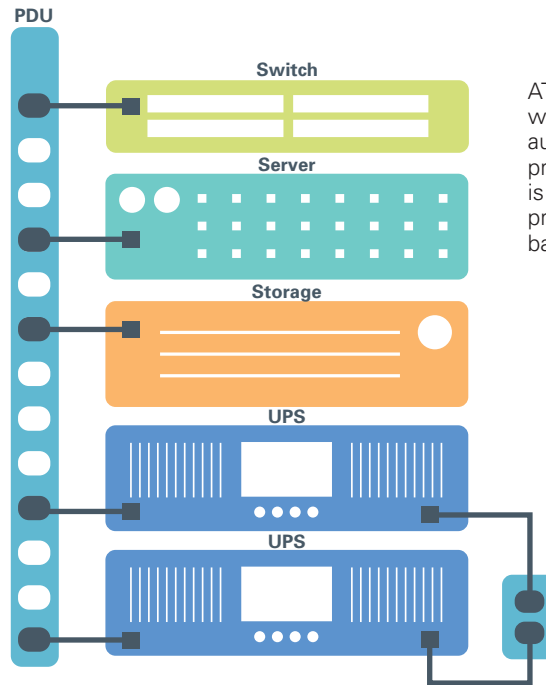

ATSs provide power redundancy to equipment with only one power supply. The ATS automatically transfers the power from a primary source to a secondary source if there is a problem with the primary. Once the primary source is restored, power transfers back through it.

### Dual feed, single UPS

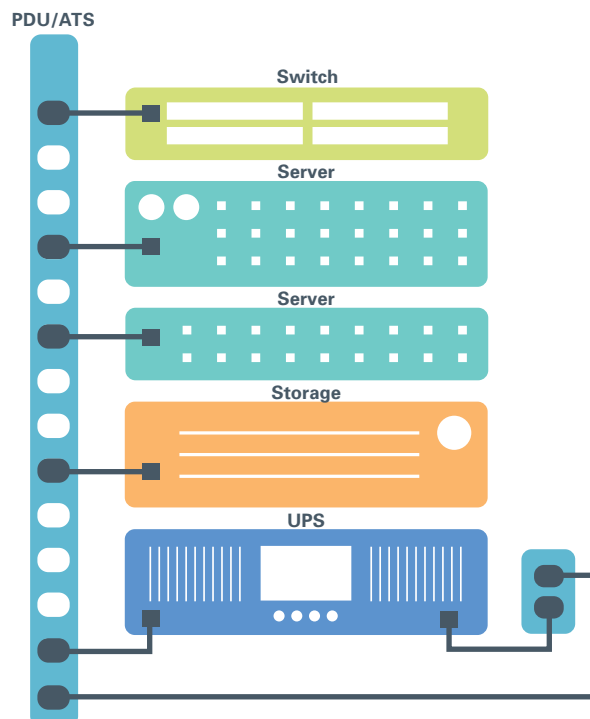

NICE SOLUTIONS,  
BUT I BELIEVE BACON  
CURES EVERYTHING!





# Service overview



One of the best ways to protect your investment is by including a service plan. Scheduled preventive maintenance can help detect a wide range of ailments before they become serious and costly issues.



Figure 1. Smaller UPS models are usually sent to a repair facility.

## Types of UPS service

There are several UPS service delivery methods, including:

- **Factory warranty—repair or replace.** You contact the UPS service provider and ship your UPS to a repair facility. The service provider returns the repaired unit or a refurbished unit.
- **Extended warranty—advance swap depot exchange.** You contact your UPS service provider, which ships a refurbished unit to you; the original UPS unit is returned to a repair facility. Typically this expedites a replacement UPS by the next business day and freight costs are paid both ways by Eaton.
- **Onsite repair.** You contact your UPS service provider and factory-trained field technicians travel to your site to diagnose and repair electronic or battery-related problems.

Smaller UPS products (below 1000 VA) generally can be repaired at a depot, while products over 1000 VA and up to 18 kVA can either be repaired at a depot or serviced onsite. Larger UPSs that are either hardwired (can't be unplugged) or too heavy to ship can only be serviced onsite by trained technicians.

**For more information on UPS service, and to access service-related white papers, please visit:**

[Eaton.com/UPSservices](http://Eaton.com/UPSservices)

## Types of service agreements

A variety of different UPS service options are available, any of which will likely save you time and money by minimizing business interruption and the costs of downtime, as well as enhancing overall return on investment by extending the lifespan of critical power equipment.

- **Support agreements, or service contracts,** usually combine parts and labor coverage (electronics, batteries or both), one or more UPS preventive maintenance inspections annually, and a combination of coverage hours and arrival response time. Plans can be tailored to meet almost any need. Special features like remote monitoring, battery replacement insurance and spare part kits may also be added.
- **Extended warranty (or basic warranty)** may also be purchased for many UPS products. A warranty commonly covers specified parts and labor such as electronic components for a fixed period of time. Warranties may have limited response times or exclude features like scheduled preventive maintenance. The more services added to a warranty, the closer it becomes to a support agreement.

- **Time and material (T&M) service** is a pay-as-you-go approach through which the service provider makes a repair only when something breaks. T&M can be done either by depot repair or onsite, depending on the UPS. This method can be an unacceptable service solution for some customers, since it's often expensive, and there's the uncertainty of not knowing when a field technician will arrive. Because support agreement (contract) customers always take priority, T&M response times can be up to five days, based on the product and location.

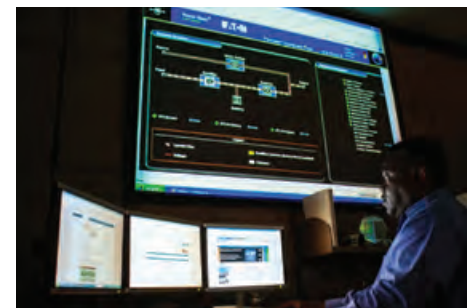

Figure 3. Eaton is one of the UPS companies that provides remote monitoring services.

## The Eaton service offering

Eaton offers power quality services for its UPS products as well as for related equipment such as power distribution units (PDUs) and batteries. Eaton also services products from legacy brands, including Powerware, Exide Electronics, Best Power, MGE Office Protection Systems, IPM, Deltec and Lortec. Eaton has more than 40 years of experience designing and servicing industry-leading UPSs for government, healthcare, industrial and data center applications.

# Electric transmission distribution system

The flow of electricity begins at the utility company, where it's created at the generating station. From there, a generator transformer at the station switchyard then steps up the voltage to minimize cable size and electrical losses.

The transmission substation then increases the voltage, which depends on the distance the power needs to travel and the amount desired. Electricity then enters the transmission system, traveling at nearly the speed of light, over heavy cables strung between tall towers. A step-down transformer located at a substation near the final destination reduces the voltage to between 22,000 and 69,000 volts, so the electricity can be carried on smaller distribution lines that carry it to the end user. Transformers that adjust the voltages down to the proper level for use are located at or near each end user facility. For commercial use, the load can range from 416 volts to 480 volts, while residential use is typically 208/120 volts in the U.S. and Canada.





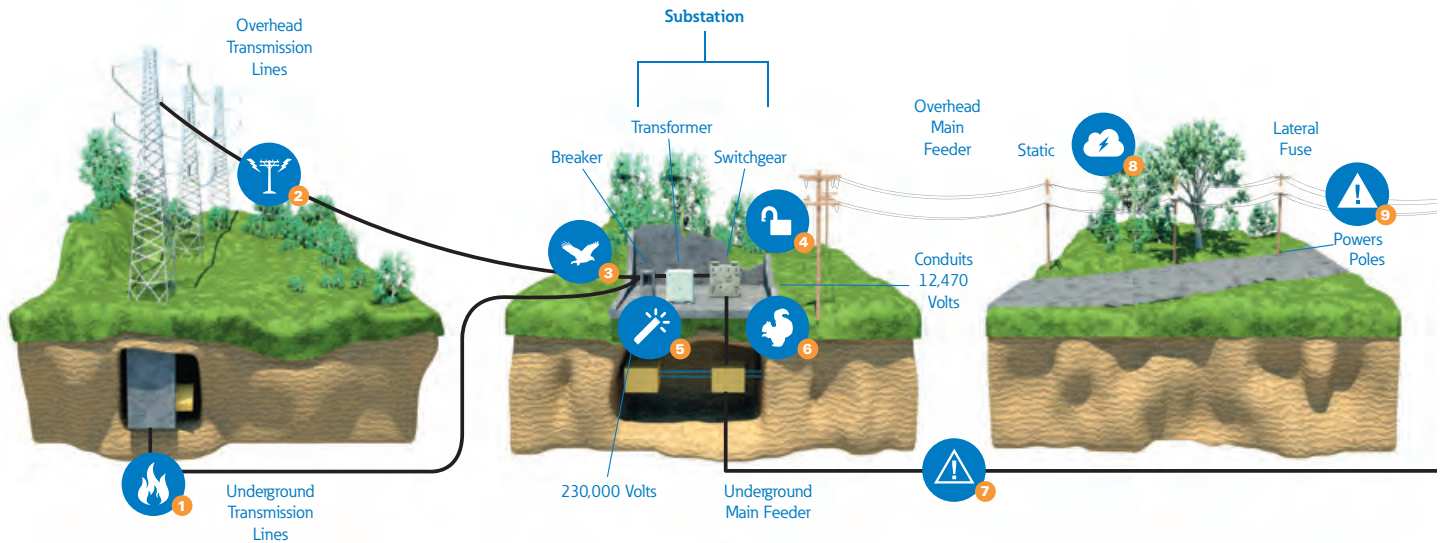

## Threats to the system

At each stage, there are a number of threats that can interrupt the flow and distribution of electricity. Everything from lightning strikes to failed equipment can severely affect the end user and disrupt important and vital processes.

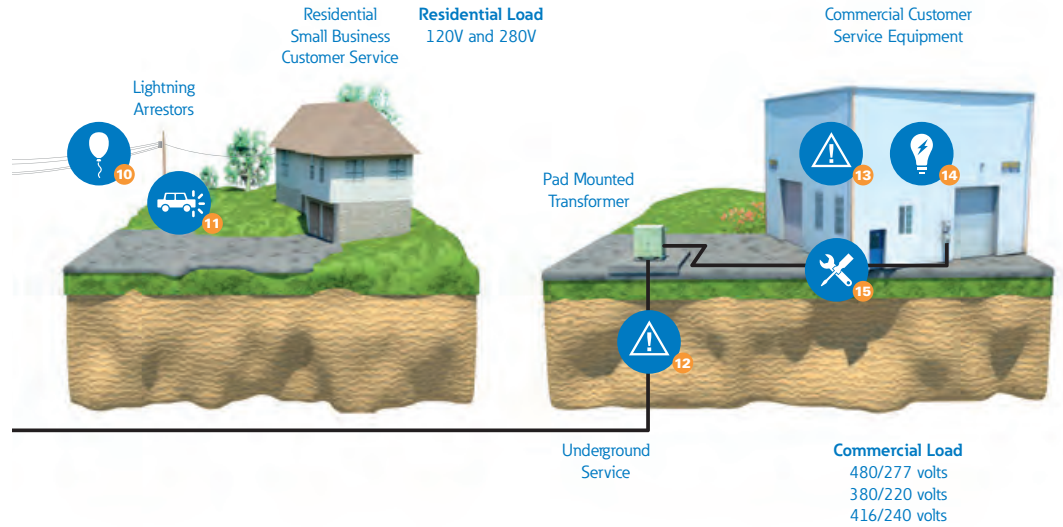

- 1 Fire sparked by weak wire burns through line
- 2 Lightning strike damages transmission line
- 3 Bird flies in causing short circuit
- 4 Thieves steal copper
- 5 Blown fuse at substation transformer

- 6 Squirrels and raccoons chew through a wire or wander into the wrong area
- 7 Underground explosion causes cable failure
- 8 Storm blows branches and limbs down that crash into power lines
- 9 Equipment malfunction

- 10 Mylar balloons drift into power lines
- 11 Three-car collision strikes utility pole
- 12 Failure of underground cable
- 13 Equipment failure
- 14 The power goes out and no one knows why
- 15 Utilities conduct a planned outage for repairs or upgrades



# Frequently asked questions

We compiled the following set of questions based on our extensive experience dealing with resellers and end users. For frequently asked questions about UPS batteries, please visit the UPS battery overview section on page 25.

## 1. What's the difference between a surge protector and a UPS?

A surge protector provides just that—surge protection. In addition to surge protection, a UPS continually regulates incoming voltage and provides battery backup in the event of a power failure. See page 19 for more on UPSs and surge suppressors.

## 2. How much capacity of a UPS should I use?

To allow for future expansion, we recommend that you install a UPS at approximately 75 percent capacity. In addition, the batteries degrade over time; by oversizing, you provide room for error. In the online Eaton UPS sizing tool ([Eaton.com/UPSselector](https://www.eaton.com/UPSselector)) we've included a "capacity used" column.

## 3. How much UPS battery runtime do I need?

During an outage, you need enough battery runtime to gracefully shut down systems or switch to backup generators. You may add an optional extended battery module (EBM) to increase runtime.

## 4. How is battery runtime impacted if I reduce the load on the UPS?

There can be a significant increase in runtime. Generally speaking, a UPS that provides five minutes at full load will provide 15 minutes at half load.

## 5. My business is too small for protective measures. Do I really need a UPS?

Power problems are equal-opportunity threats. Your PCs, servers and network are just as critical to your business as a data center is to a large enterprise. Downtime is costly in terms of hardware and potential loss of goodwill, reputation and sales. Also add in the delays that inevitably occur when rebooting locked-up equipment, restoring damaged files and re-running processes that were interrupted. A sound power protection strategy is cost-effective insurance.

## 6. Why is power quality such a problem today?

Today's high-tech IT equipment and control units are much more sensitive to electrical disturbances and are more important to the critical functions of many businesses than in the past. As a result, power quality problems today are more frequent and more costly than ever.

## 7. Are power quality problems always noticeable?

No. In many cases, disturbances can cause imperceptible damage to circuits and other components, a major cause of premature equipment failure and problems like computer lockups. Many power quality problems go unresolved, resulting in lost revenue and data.

## 8. How is reliability measured?

Power reliability is usually stated as a percent of time the power is available. For example, the power grid system in the U.S. provides three nines of reliability—the power is available for 99.9 percent of the time. Because those 8.8 hours of downtime translate into significant downtime and expense, IT and telephone network services require at least five nines of reliability.

Reliability average	Number of Nines	Non-availability per year
99%	Two nines	88 hours
99.9%	Three nines	8.5 hours
99.99%	Four nines	53 minutes
99.999%	Five nines	5.3 minutes
99.9999%	Six nines	32 seconds
99.99999%+	Seven nines	3.2 seconds

## 9. How are phone systems and IT equipment affected by inconsistent power?

Fluctuating power is a waste of valuable time and money. If customers expose their telephone systems (and any other electronic equipment) to inconsistent utility power, they're vulnerable to hardware and software damage, data corruption and communication breakdown. The time and cost of replacing equipment, as well as the business lost during breakdown and replacement, can greatly affect a company's bottom line.

## 10. I have a UPS. Am I really protected by lightning?

No, UPS or any other form of surge protection device can provide total protection against lightning-induced power surges. A good UPS will suppress the majority of surges without itself suffering damage. For larger surges, it will also offer one-off protection, where the surge protection device does its job of protecting the connected equipment, but is destroyed in the process and can, therefore, provide no further protection. While a well specified



good quality UPS will provide a very useful level of surge protection, it will do an even better job if it is used as part of a comprehensive surge protection system with several levels of protection with high-energy protection devices installed at the point where the supply enters the building, and smaller devices installed at other critical points throughout the building's power distribution system.

#### 11. We have a generator. Do I still need a UPS?

A generator will NOT protect your equipment against power problems. You need a UPS to guarantee that the equipment stays up until the generator kicks on and stabilizes—which often requires several minutes. See page 9 for more on generator and UPS compatibility.

#### 12. How much UPS capacity do I need?

Determine the total load (in watts) of the equipment you want to protect. Add 10–20 percent for future growth and decide the minimum amount of runtime you need. Use the online sizer at ([Eaton.com/UPSselector](http://Eaton.com/UPSselector)) to identify the right solution for your application.

#### 13. What are the different levels of surge protection?

There are three typical levels:

**A. Lightning arrestors.** Big and mean, usually found in large facilities located in high-risk areas. Takes an extremely high voltage and clamps it down.

**B. Surge Protective Devices (SPD or TVSS).** Mounted on your panelboard or load center; sometimes larger UPS models may have some level of this, but typically not a great amount. Clamps voltage down to even lower tolerances (~1 kV or less).

**C. Local outlet level surge protector.** A simple surge strip; small plug-and-play UPSs often have this as well. Brings voltage down to levels that will not permanently damage connected equipment (typically ~380V).

Lightning strikes have such an incredible amount of energy that only an expensive lightning arrester would protect you from a direct hit and they often don't guarantee complete protection. For the best protection against lightning strikes, you want to develop a two-stage defense with something at your panel and something at the outlet level. Visit [Eaton.com/spd](http://Eaton.com/spd) for some informative videos and additional information.

#### 14. What happens if the UPS is overloaded, for example, if the protected equipment and/or load draws more current than it can provide?

The UPS transfers the load to bypass (for a few minutes) until the overload condition is reversed. If the overload condition continues, some UPS models automatically shut down. Some models can run at 110V indefinitely in bypass.

#### 15. What causes a UPS to be overloaded?

There are two possible answers:

1. The UPS was undersized (e.g., the load is rated at 1200 VA, but a 1000 VA UPS was provided), or
2. You plugged more equipment into the UPS than it was designed to handle

#### 16. I have a 3000 VA UPS. Can I just plug the unit into a standard 15A wall outlet?

Only UPSs with power ratings up to 1500 VA plug into a standard 15A wall outlet. All others require a larger receptacle, which must be installed by an electrician.

#### 17. Why is power management software important?

Although UPSs are typically rugged and reliable, they do require ongoing monitoring and support. Power management software continuously monitors and diagnoses the state of the grid, batteries and power sources, together with the condition of the UPS's internal electronics. Eaton UPS software and connectivity cards enable remote monitoring and management capability, including graceful shutdown and load segment control.

#### 18. Will my current UPS software monitor my new Eaton UPS?

Yes, you can monitor your Eaton UPS with any UPS or facility management software that supports the industry standard Management Information Base (MIB, RFC 1628) as long as you install the optional connectivity card. Most UPS vendors support this MIB and all good facility management software, including OpenManage, OpenView and Tivoli also support it. Extended Eaton Advanced MIBs are available for greater levels of detail.

You can remotely control your Eaton UPS using the Eaton UPS management software or through a secure web interface if you choose the optional connectivity card, which also allows for automated email alerts for

power events without needing to install any software.

#### 19. My data center only went down for a couple of minutes. What's the big deal?

When a data center goes down and then back up during a power outage without a managed shut down, it doesn't come up nicely. Storage arrays initialize after servers that try to mount their shares, while some servers boot without access to DNS servers that are also booting and thus have other problems. Although the outage was short, it can take hours to get everything back online. In addition, data corruption is a serious concern.

#### 20. Where can I get technical help?

Contact your territory representative or call the Eaton UPS hotline at 1-800-356-5794 for pre-sales support and 1-800-356-5737 for technical support. You can also visit [Eaton.com/UPS](http://Eaton.com/UPS).

**A GENERATOR?  
I ALREADY HAVE  
MY OWN!**





## Other acronyms

BCDR	Business Continuity and Disaster Recover	NIC	Network Interface Card	SaaS	Software as a Solution
BYOD	Bring Your Own Device	NOC	Network Operations Center	SAN	Storage Area Network
CI	Converged Infrastructure	PABX	Private Automatic Branch Exchange	SATA	Serial Advanced Technology Attachment
CPU	Central Processing Unit	PaaS	Platform as a Service	SOA	Service-Oriented Architecture
DCIM	Data Center Infrastructure Management	PBX	Private Branch Exchange	SQL	Structured Query Language
DDoS	Distributed Denial of Service	PC	Personal Computer	SSL	Secure Socket Layer
DISA	Defense Information Systems Agency	PEBKAC	Problem Exists Between Keyboard and Computer	SVGA	Super Video Graphics Array
DNS	Domain Name System	PHI	Personal Health Information	TCP/IP	Transmission Control Protocol/Internet Protocol
DR	Disaster Recovery	PICNIC	Problem in chair not in computer	TDM	Time-division Multiplexing
DSL	Digital Subscriber Line	PMDC	Portable Modular Data Center	UC	Unified Communications
DVV or DV2	Data, Voice, Video	POTS	Plain Old Telephone System	URL	Uniform Resource Locator
E911	Enhanced 911	PSAP	Public Safety Answering Point	VDI	Virtual Desktop Infrastructure
ELT	Emergency Locator Transmitter	PSTN	Public Switched Telephone Network	VGA	Video Graphics Array
EMEA	Europe, Middle East, Africa	P2V	Physical to Virtual	VLAN	Virtual LAN
FMC	Fixed/Mobile Convergence	RAM	Random Access Memory	VoIP	Voice over Internet Protocol
FTP	File Transfer Protocol	ROBO	Remote Office/Branch Office	VM	Virtual Machine
GUI	Graphical User Interface			VPN	Virtual Private Network
GoT	Game of Thrones			WAN	Wide Area Network
HDD	Hard Disk Drive				
HPC	High-Performance Computer				
HTML	HyperText Markup Language				
HTTP	HyperText Transfer Protocol				
IOT	Internet of Things				
MDF	Main Distribution Frame				
NNM	Network Node Manager				
IaaS	Infrastructure as a Service				
IDF	Intermediate Distribution Frame				
IP	Internet Protocol				
ISP	Internet Service Provider				
KVM	Keyboard, Video, Mouse				
LEED	Leadership in Energy and Environmental Design				
MSP	Managed Service Platform				
MTDC	Multi-Tenant Data Center				
M2MI	Machine-to-Machine Interface				
NAS	Network Attached Storage				

AT OUR OFFICE, WE ALLOW BYOD. MY IT PRO BROUGHT ME.



# Glossary of power terms

In the following glossary, we've attempted to capture the common terms related to UPS and power distribution products. If you look closely, you might see us trying to have a little fun!

## Advanced Battery Management

A three-stage charging technique that automatically tests battery health. Provides advance notification when preventive maintenance is needed, allowing ample time to hot-swap batteries without ever having to shut down connected equipment significantly extending the life of your UPS's battery (and, quite possibly, your contract).

## Alternating current (AC)

An electric current that reverses its direction at regularly recurring intervals, as opposed to direct current, which is constant. Usually in a sine wave pattern, for optimal transmission of energy.

## Ampere (A or Amp)

The unit of measure for the rate of flow of electricity, analogous to gallons per minute.  $VA \times 0.7$  (power factor) = watts

## Apparent power

Applied voltage multiplied by current in an AC circuit which doesn't take the power factor into account. Unit is volt amperes (VA).

## Arc

Sparking that results when undesirable current flows between two points of differing potential due to leakage through the intermediate insulation or a leakage path due to contamination. In astronomy, an arc is the part of a circle representing the apparent course of a heavenly body.

## Audible noise

A measure of the noise emanating from a device at audible frequencies.

## Backup time

The amount of time the battery in a UPS is designed to support the load.

## Balanced load

(1) AC power system using more than two wires, where the current and voltage are of equal value in each energized conductor. (2) Laundry with equal parts of light and dark clothes.

## Battery string

A group of batteries connected together in a series.

## Blackout

A zero-voltage condition lasting for more than two cycles. Also known as a power outage or failure.

## British Thermal Unit (BTU)

Used to measure heat dissipation and is the amount of energy required to raise one pound of water one degree Fahrenheit. One pound of water at 32°F requires the transfer of 144 BTUs to freeze into solid ice.

## Brown field

An existing data center—often with limited possibilities for sustainable and energy-efficient designs.

## Brownout

A steady state of low voltage, but not zero voltage. Brownouts often occur during summer months when energy use is high.

## Canadian Standards Association (CSA)

An independent Canadian organization that tests for public safety, similar to the function of Underwriters Laboratories (UL) in the U.S. As far as we know, it doesn't set the rules for hockey.

## Capacitor

An electronic component that can store an electrical charge on conductive plates.

## Charger

(1) An electronic component in a UPS that provides regulated DC voltage to recharge batteries. (2) An inferior mascot for an inferior team in the AFC West.

## Cloud computing

(1) Internet- (cloud-) based development and use of computer technology. This new supplement, consumption and delivery model for IT services typically involves the provision of dynamically scalable, and often virtualized, resources as a service over the Internet. (2) Work done while traveling on a plane.

## Common mode noise

An undesirable voltage that appears between the power conductors and ground.

## Commercial power

The power supplied by local utility companies which can vary drastically in quality throughout the U.S. depending on location, weather and other factors.

## Communication bay

Also known as an option slot, a UPS feature that enables the addition of various connectivity cards for Web, SNMP, Modbus or serial connectivity interface capabilities.



Eaton 5P equipped with a communication bay.

## Converged infrastructure

The combination of server, storage, networking, virtualization and sometimes other resources into an integrated solution that is managed as a whole rather than through separate management systems.

## Converter

A device that delivers DC power when energized by a DC source. It's also a section of a switching power supply that performs the actual power conversion and final rectification.

## Crest factor

Usually refers to current. It's the mathematical relationship between RMS and peak current. A normal resistive load will have a crest factor of 1.4142, which is the normal relationship between peak and RMS current. A typical PC will have a crest factor of 3. Unrelated to toothpaste.

## Critical equipment

Equipment such as computers, communications systems or electronic process controls, which must be continuously available.

## Delta connection

A circuit formed by connecting three electrical devices in series to form a closed loop; most often used in three-phase connections. If you fly Delta Airlines, this most likely takes place in Atlanta, Salt Lake City or Cincinnati.

## Derating

A reduction of some operating parameters to compensate for a change in one or more other parameters. In power systems, the output power rating is generally reduced at elevated temperatures.

## Direct current (DC)

An electric current in which the flow of electrons is in one direction, such as supplied by a battery.



### DC distribution (DCD)

A module in a DC power system that distributes DC power to the loads. It also provides protection for the load cables.

### DC power system

An AC to DC power supply with integrated control and monitoring, and standby batteries designed to supply no-break DC power (usually 24V or 48V) to telecommunications and IT network equipment.

### Double conversion

A UPS design in which the primary power path consists of a rectifier and inverter. It isolates the output power from all input anomalies such as low voltage surges and frequency variations.

### Downtime

The time during which a functional unit can't be used because of a fault within it or the environment.

### Dry contacts

Dry contact refers to a contact of a relay which does not make or break a current.

### Efficiency

The ratio of output to input power. Generally measured at full-load and nominal line conditions. If the power efficiency of a device is 90 percent, you get back 90 watts for every 100 you put in, and the rest is mainly dissipated as heat from the filtration process. To think of it another way, this would be equivalent to a bartender pouring off about an ounce and a half of your beer before handing you the remaining 14.5 ounces!

### Electrical line noise

Radio frequency interference (RFI), electromagnetic interference (EMI) and other voltage or frequency disturbances.

### Electromagnetic interference (EMI)

Electrical interference that can cause equipment to work improperly, EMI can be separated into conducted EMI (interference conducted through cables out of the UPS) and radiated EMI (interference conducted through the air).

### Energy Saver System (ESS)

Innovative technology from Eaton that enables select UPS models to operate at 99 percent efficiency without compromising reliability—not to be confused with inferior “eco” modes.

### ePDU

A power distribution unit that mounts to rack enclosures and distributes power to connected devices via a wide variety of output receptacles.

### Federal Communications Commission (FCC)

A U.S. federal regulating body whose new EMI limitations are affecting the design and production of digital electronics systems and their related subassemblies.

### Flooded batteries

A form of battery where the plates are completely immersed in a liquid electrolyte.

### Frequency

The number of complete cycles of AC voltage that occur during one second (Hz). In North America, electrical current is supplied mainly at 60 Hz, or 60 cycles per second.

### Green field

A new data center with many possibilities for sustainable and energy-efficient designs.

### Ground

A conducting connection, whether intentional or accidental, by which an electric circuit or equipment is connected to the earth, or to some conducting body of relatively large extent that serves in its place.

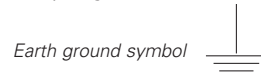

Earth ground symbol

### Harmonics

A sinusoidal component of an AC voltage that's multiple of the fundamental waveform frequency. Certain harmonic patterns may cause equipment problems

### Harmonic distortion

Regularly appearing distortion of the sine wave which is converted into a complex waveform at a multiple of the fundamental frequency.

### Hertz (Hz)

A unit of frequency equal to one cycle per second.

### High efficiency mode

A mode of UPS operation that cuts energy usage and operating costs.

### High voltage (HV)

In the context of UPS products, high voltage is anything  $\geq 200V$ : 200V, 208V, 220V, 230V, 240V, 250V, 480V and 600V.

### High voltage spike

Rapid voltage peaks up to 6,000 volts.

### Hot swappable

The ability to change a module without taking the critical load off the UPS. Also see “user replaceable.”



The batteries on this Eaton 9PX UPS are hot swappable.

### Insulated gate bipolar transistor (IGBT)

A three-terminal power semiconductor device, noted for high efficiency and fast switching. It switches electric power in many modern appliances such as electric cars, trains and UPSs.

### Impedance

The total opposition to alternating current flow in an electrical circuit.

### Input voltage range

The voltage range within which a UPS operates in “normal” mode and doesn't require battery power.

### Inrush current

The maximum, instantaneous input current drawn by an electrical device when first turned on. Some electrical devices draw several times their normal full-load current when initially energized.

### Inverter

UPS assembly that converts internal DC power to output AC power to run the user's equipment. When the inverter is supporting 100 percent of the load at all times, as with an online UPS, there is no break from utility to battery power.

### IT mullet or business mullet

Blazer on the top, jeans on the bottom.

### Kilovolt ampere (kVA)

A common measurement of equipment capacity equaling 1000 volt-amperes. An approximation of available power in an AC system that does not take the power factor into account.

### Kinetic energy

The energy an object possesses because of its motion.

### Line conditioner

A device intended to improve the quality of the power that's delivered to electrical load equipment. A line conditioner is generally designed to improve power quality (e.g., proper voltage level, noise suppression, transient impulse protection, etc.).

### Line interactive

An offline UPS topology in which the system interacts with the utility line to regulate the power to the load. Provides better protection than a standby system but isn't as fully prepared against irregularities as a full double-conversion system, making it the “Goldilocks” of UPS topologies.

### Linear load

AC electrical loads where the voltage and current waveforms are sinusoidal. The current at any time is proportional to voltage.

### Lithium-ion battery

A lightweight battery with high energy density. Its electrodes are made of lightweight lithium and carbon. Eaton utilizes a combination of lithium phosphate that creates a stable and safe battery for UPS applications. This type of chemistry does not create oxygen as an off-pur should there be a thermal event, eliminating the harsh igniting potential of some lithium-ion battery chemistries. Lithium is also a song by the band Nirvana on the ground breaking album Nevermind released on September 24, 1991.



This Eaton 5P UPS is equipped with Li-Ion batteries

### Load

The equipment connected to and protected by a UPS. Pretty rockin' Metallica album.

### Load segment

UPS configuration with separate receptacle groups, enabling scheduled shutdowns and maximum backup power time for critical devices.



This Eaton 9PX UPS is equipped with two load segments

### Low voltage (LV)

In the context of UPS products, low voltage is anything <200V (100V and 120V).

### Maintenance bypass

An external wiring path to which the load can be transferred to upgrade or perform service on the UPS without powering down the load.

### Make-before-break

Operational sequence of a switch or relay where the new connection is made prior to disconnecting the existing connection, that's also known as soft-load-transfer switching.

### Modbus

A serial communications protocol that's the most commonly available means of connecting industrial electronic devices. It allows for communication between many devices connected to the same network.

### Network transient protector

UPS feature that isolates networks, modems and cables from power threats, including surges and spikes.

### Noise

(1) A disturbance that affects a signal; it can distort the information carried by it. (2) Random variations of one or more characteristics of any entity, such as voltage, current or data. (3) Loosely, any disturbance tending to interfere with normal operation of a device. (4) What parents with children deal with every day.

### Nominal output voltage

The intended, ideal voltage of any given output.

### Non-linear load

AC electrical loads where the current is not proportional to the voltage. Non-linear loads often generate harmonics in the current waveform that lead to distortion of the voltage waveform.

### Offline

Any UPS that doesn't fit the definition of online. Line-interactive and standby topologies are offline, as are minor skirmishes that take place just outside the boardroom.

### Ohm

The unit of measurement for electrical resistance or opposition to current flow.

### Ohm's Law

The voltage (E) is equal to the current (I) times the resistance (R). The formula is written:  $E=IR$ .

### Online

(1) A UPS that provides power to the load from its inverter 100 percent of the time, regulating BOTH voltage and frequency, usually using double-conversion topology. (2) The most convenient way to shop, bank, get news, etc.

### Orderly shutdown

The sequenced shutdown of units comprising a computer system to prevent damage to it and subsequent corruption or loss of data.

### Output waveform (UPS)

The shape of the graph of alternating current on the output side of a UPS. The highest quality of an output waveform from a UPS is the sine wave, but, some UPSs provide step waves or modified sine waves.

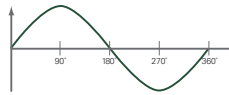

Sine wave

### Parallel operation

The ability of UPSs to be connected so the current from corresponding outputs can be combined into a single load.

### Partition

A logical division of a hard disk created to have different operating systems on the same hard disk or to create the appearance of having separate hard

drives for file management, multiple users, or other purposes.

### Peak demand

The highest 15- or 30-minute demand recorded during a 12-month period.

### Phase

The time relationship between current and voltage in AC circuits.

### Plenum cable

Cable that's laid in the plenum spaces of buildings to facilitate air circulation for heating and air conditioning systems. The plenum space is typically used to house computer and telephone network communication cables. Cable that runs between floors in non-plenum areas is rated as riser cable.

### Plug and play

An electrical device that doesn't require extensive setup to operate.

### Power factor (PF)

(1) The ratio of real power to apparent power. Watts divided by VA. Most power supplies used in communication and computer equipment have a power factor of 0.9.

$$\begin{aligned} \text{PF} &= 0.9 \\ \text{VA} \times \text{PF} &= \text{W} \\ \text{W}/\text{PF} &= \text{VA} \end{aligned}$$

(2) Why DeNiro can get immediate seating in any restaurant he wants, and you can't.

### Power sag

Low voltage (below nominal 120 volts).

### Power surge

High voltage (above nominal 120 volts).

### Pulse width modulation (PWM)

A circuit used in switching regulated power supplies where the switching frequency is held constant and the width of the power pulse is varied, controlling both lines and load changes with minimal dissipation.

### Rackmount

Ability to mount an electrical assembly into a standardized rack. Generally stacked up to 42U and 19 inches wide—about the size of a pizza box but not as greasy.

### Rack unit (U)

A unit of height measurement in a rack enclosure. A U is equivalent to 1.75 inches.



The Eaton 5PX UPS occupies 2U of rack space and the optional extended battery module also occupies 2U.

### Rail kit

A set of metal brackets that allows the installation of a UPS or extended battery module in a 2- or 4-post rack.



Four-post rail kit



UPS in a two-post rack

### Rectifier

A UPS component that converts incoming AC power to DC power for feeding the inverter and charging the battery.

### Rectifier magazine (RM)

A module in the DC power system used to connect the rectifiers in the power system.

### Redundancy

The ability to connect units in parallel so if one fails the other(s) will provide continual power to the load. This mode is used in systems when power failure can't be tolerated.

### Relay communication

Communication between a UPS and a computer through the opening and closing of solid-state relays that are pre-defined to indicate UPS status.

### Root mean square (RMS)

A modified average. Averaging a sine wave would give a zero, so to obtain meaningful values, the wave is first squared (S), then averaged over one period (M) and finally the square root taken (R). In a sine wave, the factor between RMS and peak is the square root of two. If you know what that means, you're pretty smart!

### RS-232

(1) The standard for serial interfaces (serial refers to the eight bits of each character successively sent down one wire) used by most computers, modems and printers. (2) A little known droid in the Star Wars trilogy.

### Server room

Dedicated computer room with some power and cooling, typically within an office environment. Minimal redundancy for power and cooling distribution. Singular source of power and cooling. (451 Research)

### Server closet

Small room or closet with little to no redundancy power and cooling distribution. Singular source of power and cooling. (451 Research)

### Simple Network Management Protocol (SNMP)

A User Datagram Protocol (UDP)-based network protocol. It's used mostly in network management systems to monitor network-attached devices for conditions that warrant administrative attention.

### Sine wave

A mathematical function that plots three qualities of an electrical signal over time: amplitude, frequency and phase. Clean, uninterrupted power is represented by a sine waves, which can also resemble ocean waves, though they're rarely perfect.

### Single phase

(1) Power system with one primary waveform. Lower-capacity distribution of power using only one portion of a power source that's three-phase, like what's supplied by most electric utilities. Used for heating and lighting, no large motors or other heavy-drain devices. (2) That part of junior high school in which you briefly but fiercely embrace an unusual hobby or interest, like lawn bowling, never to return to it.

### Sliding demand

Calculating average demand by averaging demand over several successive time intervals, advancing one interval at a time.

### Split-phase UPS

A UPS with two output phases referenced to a neutral connection with a specific phase displacement between phases, which allows flexibility in load configuration while maintaining the availability of bypass. A split-phase UPS can provide 120V and 208V on the output simultaneously without the use of an external transformer. The capabilities for output are:

- Phase to neutral 100, 110, 120 or 127 Vac
- Phase to phase 200, 208, 220, 230, 240 Vac

### Standby

(1) UPS type that "stands by," waiting for a power problem from the utility company and rapidly switching to UPS battery power to protect equipment against power failures, sags and surges. (2) The person you call after your hot date falls through, and the two of you go out for milkshakes in your sweatpants instead.

### Static switch

An electrical component in a UPS that turns power flow on and off on command without moving or mechanical components.

### Step load

An instantaneous change in the loading conditions presented to the output of a UPS.

### Switching Frequency

The rate at which the source voltage is switched in a switching regulator or chopped in a DC-to-DC converter.

### Technischer Überwachungs-Verein (TUV)

An independent non-profit organization that tests and certifies electrical equipment for public safety in the U.S. and worldwide.

### The Far Side

The greatest cartoon strip ever. Created by Gary Larson.

### Thermal regulation

Monitoring the temperature of the batteries to ensure proper charging.

### Three phase

(1) Power supplied through at least three wires, each carrying power from a common generator but offset in its cycle from the other two. Used for heavy-duty applications. (2) The universal healing process after buying inferior power protection:

1. Denial
2. Anger
3. Calling Eaton

### Topology (UPS)

The core technology of a UPS. Typically, a UPS is either standby, line interactive or online though other hybrid technologies have been introduced.

### Total harmonic distortion (THD)

(1) How much the circuit voltage deviates from a perfect sine wave. When viewed on a meter, a poor voltage THD is most often manifested in a flat-topped waveform that comes from the inability of a power source to respond to the demands of highly nonlinear loads. (2) The parts of a difficult lecture that didn't quite make it into your brain, but rather united in a "blahblahblah" cacophony of scratchy-sounding jargon and esoteric corollaries.

### Transfer time

The length of time it takes a UPS to transfer to battery power. Typically measured in milliseconds (ms).

### Transformer

(1) A magnetic device that converts AC voltages to AC voltages at any level. An ideal transformer is a lossless device in which no energy is stored that requires no magnetic current. (2) An alien robot that can disguise itself by transforming into everyday machinery.

### Transient

(1) A temporary and brief change in a given parameter, typically associated with input voltage or output loading parameters. (2) Transient killer whale pods are generally comprised of an adult female and two or three of her offspring. Among the differences between residents and transients are that while resident orcas of both sexes stay within shouting distance of their mothers their entire lives, only first-born male transients maintain such intense fidelity to their mothers.

### Unbalanced load

(1) An AC power system using more than two wires, where the current is not equal due to an uneven loading of the phases. (2) A load that makes your washing machine go, "whump, whump, whump."

### Underwriters Laboratories (UL)

An independent non-profit organization that tests for public safety in the U.S. UL recognition is required for equipment used in some applications.

### Uninterruptible power system (UPS)

(1) An electrical system designed to provide instant, transient-free backup power during power failure or fault. Some UPSs also filter and/or regulate utility power (line conditioning). (2) A Device whose sole purpose is to save your equipment, your data and your job.

### User replaceable

Capable of being replaced by an end user. Connected equipment may need to be shut down first. Also see "hot swappable."

### Variable Module Management System (VMMS)

Innovative technology from Eaton that maximizes UPS efficiencies at low load levels while supplying the load with continuous double-conversion power.

### Virtualization

The creation of a virtual (rather than actual) version of something, such as an operating system, server, storage device or network resource. Operating system virtualization is the use of software to allow a piece of hardware to run multiple operating system images at the same time.

### Volt/voltage (V)

Electrical pressure that pushes current through a circuit. High voltage in a computer circuit is represented by 1, while low (or zero) voltage is represented by 0.

### Volt amps (VA)

(1) The voltage applied to a given piece of equipment, multiplied by the current it draws. Not to be confused with watts, which are similar but represent the actual power drawn by the equipment, and can be somewhat lower than the VA rating. (2) Legendary Brigadier General from Planet Zap.

### Watts (W)

The measure of real power. It's the rate of doing electrical work.  $W \times 1.3 = VA$ .

### Wye connection

A connection of three components made in such a manner that one end of each component is connected. It's generally used to connect devices to a three-phase power system.



I NEED SOME PERSONAL SPACE AFTER READING SO MUCH.



JEM Tech Group  
23537 Lakepointe Drive, Clinton Township, MI 48036  
(586) 783-3400 | support@jemtechgroup.com  
JEMtechgroup.com



© 2020 Eaton  
All Rights Reserved  
COR172FYA / GG  
May 2020

Eaton is a registered trademark.

All other trademarks are property of their respective owners.

Follow us on social media to get the latest product and support information.

